

# REALTEK SINGLE CHIP FAST ETHERNET CONTROLLER WITH POWER MANAGEMENT RTL8100B(L)

<b>1. Features</b> .....	<b>2</b>	<b>6. EEPROM (93C46) Contents</b> .....	<b>32</b>
<b>2. General Description</b> .....	<b>3</b>	6.1 Summary of the RTL8100B(L) EEPROM Registers...34	
<b>3. Pin Assignments</b> .....	<b>4</b>	6.2 Summary of EEPROM Power Management Registers .34	
<b>4. Pin Description</b> .....	<b>6</b>	<b>7. PCI Configuration Space Registers</b> .....	<b>35</b>
4.1 Power Management/Isolation Interface.....	6	7.1 PCI Configuration Space Table .....	35
4.2 PCI Interface .....	6	7.2 PCI Configuration Space Functions.....	37
4.3 EPROM/EEPROM Interface.....	8	7.3 Default Values after Power-on (RSTB asserted) ..40	
4.4 Power Pins.....	8	7.4 PCI Power Management Functions.....	41
4.5 LED Interface.....	8	7.5 VPD (Vital Product Data).....	43
4.6 Attachment Unit Interface .....	9	<b>8. Block Diagram</b> .....	<b>44</b>
4.7 Test and Other Pins .....	9	<b>9. Functional Description</b> .....	<b>45</b>
<b>5. Register Descriptions</b> .....	<b>10</b>	9.1 Transmit operation .....	45
5.1 Receive Status Register in Rx packet header .....	12	9.2 Receive operation.....	45
5.2 Transmit Status Register.....	13	9.3 Wander Compensation.....	45
5.3 ERSR: Early Rx Status Register.....	14	9.4 Signal Detect.....	45
5.4 Command Register .....	14	9.5 Line Quality Monitor .....	45
5.5 Interrupt Mask Register.....	15	9.6 Clock Recovery Module .....	45
5.6 Interrupt Status Register.....	15	9.7 Loopback Operation.....	45
5.7 Transmit Configuration Register.....	16	9.8 Tx Encapsulation .....	46
5.8 Receive Configuration Register .....	17	9.9 Collision.....	46
5.9 9346CR: 93C46 Command Register .....	19	9.10 Rx Decapsulation.....	46
5.10 CONFIG 0: Configuration Register 0 .....	20	9.11 Flow Control.....	46
5.11 CONFIG 1: Configuration Register 1 .....	20	9.11.1. Control Frame Transmission .....	46
5.12 Media Status Register.....	21	9.11.2. Control Frame Reception .....	46
5.13 CONFIG 3: Configuration Register3 .....	22	9.12 LED Functions.....	47
5.14 CONFIG 4: Configuration Register4 .....	23	9.12.1 10/100 Mbps Link Monitor.....	47
5.15 Multiple Interrupt Select Register .....	24	9.12.2 LED_RX .....	47
5.16 PCI Revision ID .....	24	9.12.3 LED_TX.....	47
5.17 Transmit Status of All Descriptors (TSAD) Register ..	25	9.12.4 LED_TX+LED_RX .....	48
5.18 Basic Mode Control Register .....	25	<b>10. Application Diagram</b> .....	<b>48</b>
5.19 Basic Mode Status Register.....	26	<b>11. Electrical Characteristics</b> .....	<b>49</b>
5.20 Auto-Negotiation Advertisement Register.....	27	11.1 Temperature Limit Ratings .....	49
5.21 Auto-Negotiation Link Partner Ability Register .....	28	11.2 DC Characteristics .....	49
5.22 Auto-Negotiation Expansion Register.....	28	11.2.1 Supply voltage.....	49
5.23 Disconnect Counter.....	29	11.2.2 Supply voltage.....	49
5.24 False Carrier Sense Counter.....	29	11.3 AC Characteristics .....	50
5.25 NWay Test Register .....	29	11.3.1 PCI Bus Operation Timing.....	50
5.26 RX_ER Counter .....	29	<b>12. Mechanical Dimensions</b> .....	<b>56</b>
5.27 CS Configuration Register .....	30	12.1 QFP .....	56
5.28 Config5: Configuration Register 5 .....	31	12.2 LQFP.....	57

## 1. Features

- 100 pin QFP/LQFP
  - Integrated Fast Ethernet MAC, Physical chip and transceiver in one chip
  - 10 Mb/s and 100 Mb/s operation
  - Supports 10 Mb/s and 100 Mb/s N-way Auto-negotiation operation
  - PCI local bus single-chip Fast Ethernet controller
    - ✧ Compliant to PCI Revision 2.2
    - ✧ Supports PCI clock 16.75MHz-40MHz
    - ✧ Supports PCI target fast back-to-back transaction
    - ✧ Provides PCI bus master data transfers and PCI memory space or I/O space mapped data transfers of RTL8100B(L)'s operational registers
    - ✧ Supports PCI VPD (Vital Product Data)
    - ✧ Supports ACPI, PCI power management
  - Supports 25MHz crystal or 25MHz OSC as the internal clock source. The frequency deviation of either crystal or OSC must be within 50 PPM.
  - Compliant to PC99/PC2001 standard
  - Supports Wake-On-LAN function and remote wake-up (Magic Packet\*, LinkChg and Microsoft® wake-up frame)
  - Supports 4 Wake-On-LAN (WOL) signals (active high, active low, positive pulse, and negative pulse)
  - Supports auxiliary power-on internal reset, to be ready for remote wake-up when main power still remains off
  - Supports auxiliary power auto-detect, and sets the related capability of power management registers in PCI configuration space.
  - Includes a programmable, PCI burst size and early Tx/Rx threshold.
  - Supports a 32-bit general-purpose timer with the external PCI clock as clock source, to generate timer-interrupt
  - Contains two large (2Kbyte) independent receive and transmit FIFOs
  - Advanced power saving mode when LAN function or wakeup function is not used
  - Uses 93C46 (64\*16-bit EEPROM) to store resource configuration, ID parameter, and VPD data.
  - Supports LED pins for various network activity indications
  - Supports loopback capability
  - Half/Full duplex capability
  - Supports Full Duplex Flow Control (IEEE 802.3x)
  - 2.5/3.3V power supply with 5V tolerant I/Os.
  - 0.25u CMOS process
- \* Third-party brands and names are the property of their respective owners.

Note: The model number of the QFP package is RTL8100B. The LQFP package model number is RTL8100BL.

## 2. General Description

The Realtek RTL8100B(L) is a highly integrated, cost-effective single-chip Fast Ethernet controller that provides 32-bit performance, PCI bus master capability, and full compliance with IEEE 802.3u 100Base-T specifications and IEEE 802.3x Full Duplex Flow Control. It also supports the Advanced Configuration Power management Interface (ACPI), PCI power management for modern operating systems that are capable of Operating System Directed Power Management (OSPM) to achieve the most efficient power management possible. The RTL8100B(L) does not support CardBus mode as the RTL8139C does.

In addition to the ACPI feature, the RTL8100B(L) also supports remote wake-up (including AMD Magic Packet, LinkChg, and Microsoft® wake-up frame) in both ACPI and APM environments. The RTL8100B(L) is capable of performing an internal reset through the application of auxiliary power. When auxiliary power is applied and the main power remains off, the RTL8100B(L) is ready and waiting for the Magic Packet or Link Change to wake the system up. Also, the LWAKE pin provides 4 different output signals including active high, active low, positive pulse, and negative pulse. The versatility of the RTL8100B(L) LWAKE pin provides motherboards with Wake-On-LAN (WOL) functionality.

The RTL8100B(L) also supports Analog Auto-Power-down, that is, the analog part of the RTL8100B(L) can be shut down temporarily according to user requirements or when the RTL8100B(L) is in a power down state with the wakeup function disabled. In addition, when the analog part is shut down and the IsolateB pin is low (i.e. the main power is off), then both the analog and digital parts stop functioning and the power consumption of the RTL8100B(L) will be negligible. The RTL8100B(L) also supports an auxiliary power auto-detect function, and will auto-configure related bits of their own PCI power management registers in PCI configuration space.

The PCI Vital Product Data (VPD) is also supported to provide the information that uniquely identifies hardware (i.e., the OEM brand name of RTL8100B(L) LAN card). The information may consist of part number, serial number, and other detailed information.

To provide cost down support, the RTL8100B(L) is capable of using a 25MHz crystal or OSC as its internal clock source.

The RTL8100B(L) keeps network maintenance costs low and eliminates usage barriers. It is the easiest way to upgrade a network from 10 to 100Mbps. It also supports full-duplex operation, making 200Mbps bandwidth possible at no additional cost. To improve compatibility with other brands' products, the RTL8100B(L) is also capable of receiving packets with InterFrameGap no less than 40 Bit-Time. The RTL8100B(L) is highly integrated and requires no "glue" logic or external memory.

### 3. Pin Assignments

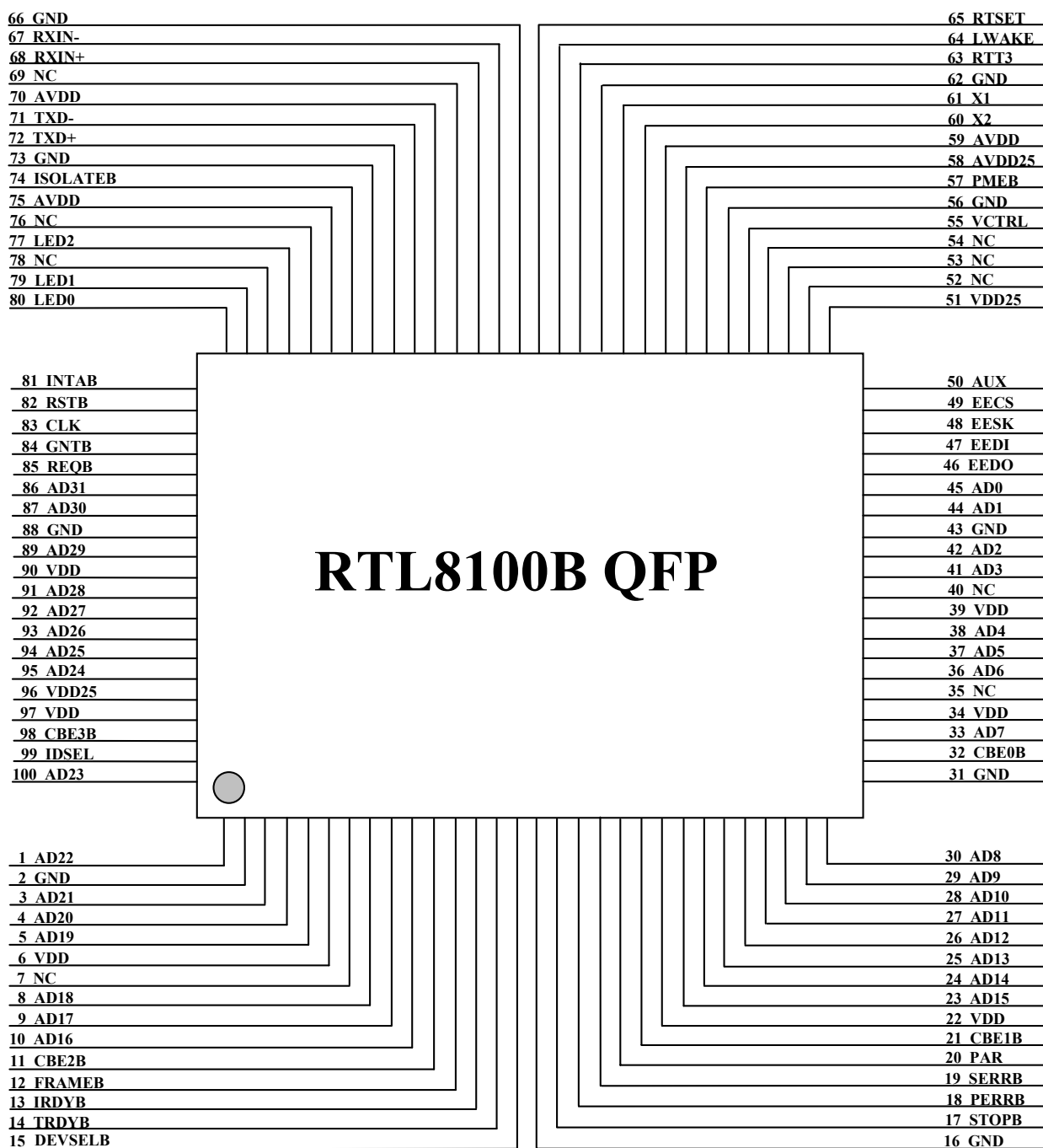

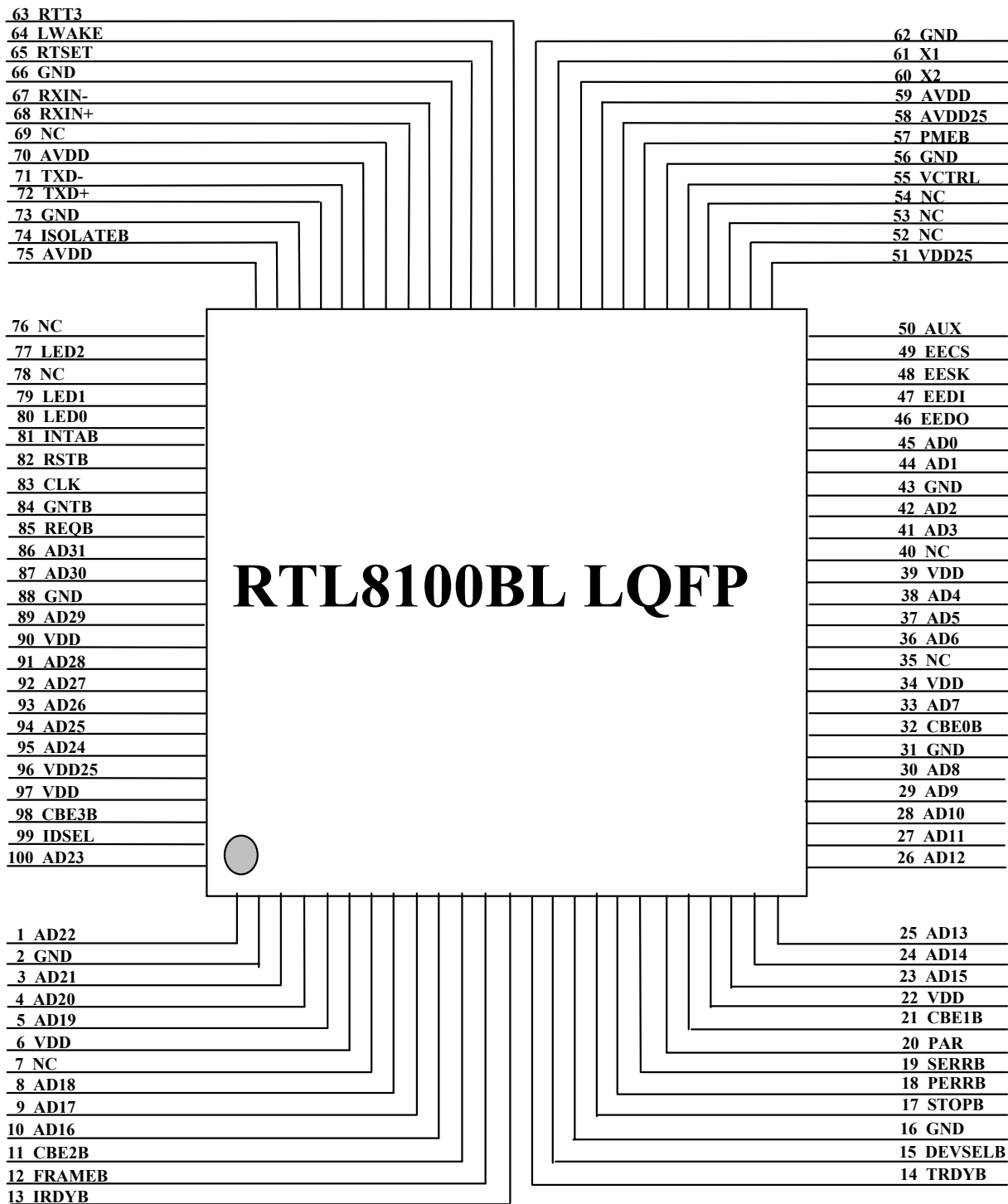

## 4. Pin Description

### 4.1 Power Management/Isolation Interface

Symbol	Type	Pin No	Description
PMEB (PME#)	O/D	57	<b>Power Management Event:</b> Open drain, active low. Used by the RTL8100B(L) to request a change in its current power management state and/or to indicate that a power management event has occurred.
ISOLATEB (ISOLATE#)	I	74	<b>Isolate Pin:</b> Active low. Used to isolate the RTL8100B(L) from the PCI bus. The RTL8100B(L) does not drive its PCI outputs (excluding PME#) and does not sample its PCI input (including RST# and PCICLK) as long as the Isolate pin is asserted.
LWAKE	O	64	<b>LAN WAKE-UP Signal:</b> This signal is used to inform the motherboard to execute the wake-up process. The motherboard must support Wake-On-LAN (WOL). There are 4 choices of output, including active high, active low, positive pulse, and negative pulse, that may be asserted from the LWAKE pin. Please refer to the LWACT bit in the CONFIG1 register and the LWPTN bit in the CONFIG4 register for the setting of this output signal. The default output is an active high signal. Once a PME event is received, the LWAKE and PME# assert at the same time when the LWPME (bit4, CONFIG4) is set to 0. If the LWPME is set to 1, the LWAKE asserts only when the PME# asserts and the ISOLATEB is low. This pin is a 3.3V signaling output pin.

### 4.2 PCI Interface

Symbol	Type	Pin No	Description
AD31-0	T/S	86,87,89,91-95,100, 1,3-5,8-10,23-30,33, 36-38,41,42,44,45	<b>PCI Address and Data Multiplexed Pins</b>
C/BE3-0	T/S	98,11,21,32	PCI bus command and byte enables multiplexed pins.
CLK	I	83	<b>Clock:</b> This PCI Bus clock provides timing for all transactions and bus phases, and is input to PCI devices. The rising edge defines the start of each phase. The clock frequency ranges from 0 to 40MHz. For normal network operation, the RTL8100B(L) requires a minimum PCI clock frequency of 16.75MHz.
DEVSELB	S/T/S	15	<b>Device Select:</b> As a bus master, the RTL8100B (L) samples this signal to insure that a PCI target recognizes the destination address for the data transfer. As a target, the RTL8100B(L) asserts this signal low when it recognizes its target address after FRAMEB is asserted.
FRAMEB	S/T/S	12	<b>Cycle Frame:</b> As a bus master, this pin indicates the beginning and duration of an access. FRAMEB is asserted low to indicate the start of a bus transaction. While FRAMEB is asserted, data transfer continues. When FRAMEB is deasserted, the transaction is in the final data phase. As a target, the device monitors this signal before decoding the address to check if the current transaction is addressed to it.

GNTB	I	84	<b>Grant:</b> This signal is asserted low to indicate to the RTL8100B(L) that the central arbiter has granted ownership of the bus to the RTL8100B(L). This input is used when the RTL8100B(L) is acting as a bus master.
REQB	T/S	85	<b>Request:</b> The RTL8100B(L) will assert this signal low to request the ownership of the bus from the central arbiter.
IDSEL	I	99	<b>Initialization Device Select:</b> This pin allows the RTL8100B(L) to identify when configuration read/write transactions are intended for it.
INTAB	O/D	81	<b>INTAB:</b> Used to request an interrupt. It is asserted low when an interrupt condition occurs, as defined by the Interrupt Status, Interrupt Mask and Interrupt Enable registers.
IRDYB	S/T/S	13	<b>Initiator Ready:</b> This indicates the initiating agent's ability to complete the current data phase of the transaction. As a bus master, this signal will be asserted low when the RTL8100B(L) is ready to complete the current data phase transaction. This signal is used in conjunction with the TRDYB signal. Data transaction takes place at the rising edge of CLK when both IRDYB and TRDYB are asserted low. As a target, this signal indicates that the master has put data on the bus.
TRDYB	S/T/S	14	<b>Target Ready:</b> This indicates the target agent's ability to complete the current phase of the transaction. As a bus master, this signal indicates that the target is ready for the data during write operations and with the data during read operations. As a target, this signal will be asserted low when the (slave) device is ready to complete the current data phase transaction. This signal is used in conjunction with the IRDYB signal. Data transaction takes place at the rising edge of CLK when both IRDYB and TRDYB are asserted low.
PAR	T/S	20	<b>Parity:</b> This signal indicates even parity across AD31-0 and C/BE3-0 including the PAR pin. As a master, PAR is asserted during address and write data phases. As a target, PAR is asserted during read data phases.
PERRB	S/T/S	18	<b>Parity Error:</b> When the RTL8100B(L) is the bus master and a parity error is detected, the RTL8100B(L) asserts both SERR bit in ISR and Configuration Space command bit 8 (SERRB enable). Next, it completes the current data burst transaction, then stops operation and resets itself. After the host clears the system error, the RTL8100B(L) continues its operation. When the RTL8100B(L) is the bus target and a parity error is detected, the RTL8100B(L) asserts this PERRB pin low.
SERRB	O/D	19	<b>System Error:</b> If an address parity error is detected and Configuration Space Status register bit 15 (detected parity error) is enabled, RTL8100B(L) asserts both SERRB pin low and bit 14 of Status register in Configuration Space.
STOPB	S/T/S	17	<b>Stop:</b> Indicates the current target is requesting the master to stop the current transaction.
RSTB	I	82	<b>Reset:</b> When RSTB is asserted low, the RTL8100B(L) performs internal system hardware reset. RSTB must be held for a minimum of 120 ns.

### 4.3 EPROM/EEPROM Interface

Symbol	Type	Pin No	Description
AUX	I	50	<b>Aux. Power Detect:</b> This pin is used to notify the RTL8100B(L) of the existence of Aux. power during initial power-on or a PCI reset. This pin should be pulled high to the Aux. power via a resistor to detect the Aux. power. Doing so, will enable wakeup support from ACPI D3 cold or APM power-down. If this pin is not pulled high, the RTL8100B(L) assumes that no Aux. power exists.
EESK	O	48	The MA2-0 pins are switched to EESK, EEDI, EEDO in 93C46 programming or auto-load mode.
EEDI	O	47	
EEDO	O, I	46	
EECS	O	49	<b>EEPROM chip select</b>

### 4.4 Power Pins

Symbol	Type	Pin No	Description
VDD	P	6,22,34,39,90,97	<b>+3.3V (Digital)</b>
AVDD	P	59,70,75	<b>+3.3V (Analog)</b>
VDD25	P	51,96	<b>+2.5V (Digital)</b>
AVDD25	P	58	<b>+2.5V (Analog)</b>
GND	P	2,16,31,43,56, 62,66,73,88	<b>Ground</b>

### 4.5 LED Interface

Symbol	Type	Pin No	Description																				
LED0, 1, 2	O	80,79,77	<b>LED pins</b> <table border="1" data-bbox="738 1393 1449 1529"> <thead> <tr> <th>LEDS1-0</th> <th>00</th> <th>01</th> <th>10</th> <th>11</th> </tr> </thead> <tbody> <tr> <td><b>LED0</b></td> <td>TX/RX</td> <td>TX/RX</td> <td>TX</td> <td>TX</td> </tr> <tr> <td><b>LED1</b></td> <td>LINK100</td> <td>LINK10/100</td> <td>LINK10/100</td> <td>LINK100</td> </tr> <tr> <td><b>LED2</b></td> <td>LINK10</td> <td>FULL</td> <td>RX</td> <td>LINK10</td> </tr> </tbody> </table> <p>During power down mode, the LEDs are OFF.</p>	LEDS1-0	00	01	10	11	<b>LED0</b>	TX/RX	TX/RX	TX	TX	<b>LED1</b>	LINK100	LINK10/100	LINK10/100	LINK100	<b>LED2</b>	LINK10	FULL	RX	LINK10
LEDS1-0	00	01	10	11																			
<b>LED0</b>	TX/RX	TX/RX	TX	TX																			
<b>LED1</b>	LINK100	LINK10/100	LINK10/100	LINK100																			
<b>LED2</b>	LINK10	FULL	RX	LINK10																			



## 4.6 Attachment Unit Interface

Symbol	Type	Pin No	Description
TXD+	O	72	100/10BASE-T transmit (Tx) data.
TXD-	O	71	
RXIN+	I	68	100/10BASE-T receive (Rx) data.
RXIN-	I	67	
X1	I	61	25 MHz crystal/OSC. input.
X2	O	60	<b>Crystal Feedback Output:</b> This output is used in crystal connection only. It must be left open when X1 is driven with an external 25 MHz oscillator.

## 4.7 Test and Other Pins

Symbol	Type	Pin No	Description
RTT3	TEST	63	<b>Chip test pin</b>
RTSET	I/O	65	This pin must be pulled low by a resistor. Please refer to the application circuit for the correct value.
VCTRL	Analog	55	Use this pin and an external PNP type transistor to generate +2.5V for the RTL8100B(L).
NC	-	7,35,40, 52,53, 54, 69, 76, 78	<b>Reserved</b>

## 5. Register Descriptions

The RTL8100B(L) provides the following set of operational registers mapped into PCI memory space or I/O space.

Offset	R/W	Tag	Description
0000h	R/W	IDR0	<b>ID Register 0:</b> ID registers 0-5 are only permitted to read/write by 4-byte access. Read access can be byte, word, or double word access. The initial value is autoloaded from the EEPROM EthernetID field.
0001h	R/W	IDR1	<b>ID Register 1</b>
0002h	R/W	IDR2	<b>ID Register 2</b>
0003h	R/W	IDR3	<b>ID Register 3</b>
0004h	R/W	IDR4	<b>ID Register 4</b>
0005h	R/W	IDR5	<b>ID Register 5</b>
0006h-0007h	-	-	<b>Reserved</b>
0008h	R/W	MAR0	<b>Multicast Register 0:</b> The MAR register 0-7 are only permitted to read/write by 4-byte access. Read access can be byte, word, or double word access. Driver is responsible for initializing these registers.
0009h	R/W	MAR1	<b>Multicast Register 1</b>
000Ah	R/W	MAR2	<b>Multicast Register 2</b>
000Bh	R/W	MAR3	<b>Multicast Register 3</b>
000Ch	R/W	MAR4	<b>Multicast Register 4</b>
000Dh	R/W	MAR5	<b>Multicast Register 5</b>
000Eh	R/W	MAR6	<b>Multicast Register 6</b>
000Fh	R/W	MAR7	<b>Multicast Register 7</b>
0010h-0013h	R/W	TSD0	<b>Transmit Status of Descriptor 0</b>
0014h-0017h	R/W	TSD1	<b>Transmit Status of Descriptor 1</b>
0018h-001Bh	R/W	TSD2	<b>Transmit Status of Descriptor 2</b>
001Ch-001Fh	R/W	TSD3	<b>Transmit Status of Descriptor 3</b>
0020h-0023h	R/W	TSAD0	<b>Transmit Start Address of Descriptor0</b>
0024h-0027h	R/W	TSAD1	<b>Transmit Start Address of Descriptor1</b>
0028h-002Bh	R/W	TSAD2	<b>Transmit Start Address of Descriptor2</b>
002Ch-002Fh	R/W	TSAD3	<b>Transmit Start Address of Descriptor3</b>
0030h-0033h	R/W	RBSTART	<b>Receive (Rx) Buffer Start Address</b>
0034h-0035h	R	ERBCR	<b>Early Receive (Rx) Byte Count Register</b>
0036h	R	ERSR	<b>Early Rx Status Register</b>
0037h	R/W	CR	<b>Command Register</b>
0038h-0039h	R/W	CAPR	<b>Current Address of Packet Read</b>
003Ah-003Bh	R	CBR	<b>Current Buffer Address:</b> The initial value is 0000h. It reflects total received byte-count in the Rx buffer.
003Ch-003Dh	R/W	IMR	<b>Interrupt Mask Register</b>
003Eh-003Fh	R/W	ISR	<b>Interrupt Status Register</b>
0040h-0043h	R/W	TCR	<b>Transmit (Tx) Configuration Register</b>
0044h-0047h	R/W	RCR	<b>Receive (Rx) Configuration Register</b>
0048h-004Bh	R/W	TCTR	<b>Timer Count Register:</b> This register contains a 32-bit general-purpose timer. Writing any value to this 32-bit register will reset the original timer and begin to count from zero.
004Ch-004Fh	R/W	MPC	<b>Missed Packet Counter:</b> Indicates the number of packets discarded due to Rx FIFO overflow. It is a 24-bit counter. After s/w reset, MPC is cleared. Only the lower 3 bytes are valid. When any value is written, MPC will be reset also.
0050h	R/W	9346CR	<b>93C46 Command Register</b>
0051h	R/W	CONFIG0	<b>Configuration Register 0</b>

0052h	R/W	CONFIG1	<b>Configuration Register 1</b>
0053H	-	-	<b>Reserved</b>
0054h-0057h	R /W	TimerInt	<b>Timer Interrupt Register:</b> Once having written a nonzero value to this register, the Timeout bit of the ISR register will be set whenever the TCTR reaches to this value. The Timeout bit will never be set as long as the TimerInt register is zero.
0058h	R/W	MSR	<b>Media Status Register</b>
0059h	R/W	CONFIG3	<b>Configuration register 3</b>
005Ah	R/W	CONFIG4	<b>Configuration register 4</b>
005Bh	-	-	<b>Reserved</b>
005Ch-005Dh	R/W	MULINT	<b>Multiple Interrupt Select</b>
005Eh	R	RERID	<b>PCI Revision ID = 10h.</b>
005Fh	-	-	<b>Reserved</b>
0060h-0061h	R	TSAD	<b>Transmit Status of All Descriptors</b>
0062h-0063h	R/W	BMCR	<b>Basic Mode Control Register</b>
0064h-0065h	R	BMSR	<b>Basic Mode Status Register</b>
0066h-0067h	R/W	ANAR	<b>Auto-Negotiation Advertisement Register</b>
0068h-0069h	R	ANLPAR	<b>Auto-Negotiation Link Partner Register</b>
006Ah-006Bh	R	ANER	<b>Auto-Negotiation Expansion Register</b>
006Ch-006Dh	R	DIS	<b>Disconnect Counter</b>
006Eh-006Fh	R	FCSC	<b>False Carrier Sense Counter</b>
0070h-0071h	R/W	NWAYTR	<b>N-way Test Register</b>
0072h-0073h	R	REC	<b>RX_ER Counter</b>
0074h-0075h	R/W	CSCR	<b>CS Configuration Register</b>
0076-0077h	-	-	<b>Reserved</b>
0078h-007Bh	R/W	PHY1_PARM	<b>PHY parameter 1</b>
007Ch-007Fh	R/W	TW_PARM	<b>Twister parameter</b>
0080h	R/W	PHY2_PARM	<b>PHY parameter 2</b>
0081-0083h	-	-	<b>Reserved</b>
0084h	R/W	CRC0	<b>Power Management CRC register0 for wakeup frame0</b>
0085h	R/W	CRC1	<b>Power Management CRC register1 for wakeup frame1</b>
0086h	R/W	CRC2	<b>Power Management CRC register2 for wakeup frame2</b>
0087h	R/W	CRC3	<b>Power Management CRC register3 for wakeup frame3</b>
0088h	R/W	CRC4	<b>Power Management CRC register4 for wakeup frame4</b>
0089h	R/W	CRC5	<b>Power Management CRC register5 for wakeup frames5</b>
008Ah	R/W	CRC6	<b>Power Management CRC register6 for wakeup frame6</b>
008Bh	R/W	CRC7	<b>Power Management CRC register7 for wakeup frame7</b>
008Ch-0093h	R/W	Wakeup0	<b>Power Management wakeup frame0 (64bit)</b>
0094h-009Bh	R/W	Wakeup1	<b>Power Management wakeup frame1 (64bit)</b>
009Ch-00A3h	R/W	Wakeup2	<b>Power Management wakeup frame2 (64bit)</b>
00A4h-00ABh	R/W	Wakeup3	<b>Power Management wakeup frame3 (64bit)</b>
00ACh-00B3h	R/W	Wakeup4	<b>Power Management wakeup frame4 (64bit)</b>
00B4h-00BBh	R/W	Wakeup5	<b>Power Management wakeup frame5 (64bit)</b>
00BCh-00C3h	R/W	Wakeup6	<b>Power Management wakeup frame6 (64bit)</b>
00C4h-00CBh	R/W	Wakeup7	<b>Power Management wakeup frame7 (64bit)</b>
00CCh	R/W	LSBCRC0	<b>LSB of the mask byte of wakeup frame0 within offset 12 to 75</b>
00CDh	R/W	LSBCRC1	<b>LSB of the mask byte of wakeup frame1 within offset 12 to 75</b>
00CEh	R/W	LSBCRC2	<b>LSB of the mask byte of wakeup frame2 within offset 12 to 75</b>
00CFh	R/W	LSBCRC3	<b>LSB of the mask byte of wakeup frame3 within offset 12 to 75</b>
00D0h	R/W	LSBCRC4	<b>LSB of the mask byte of wakeup frame4 within offset 12 to 75</b>
00D1h	R/W	LSBCRC5	<b>LSB of the mask byte of wakeup frame5 within offset 12 to 75</b>

00D2h	R/W	LSBCRC6	<b>LSB of the mask byte of wakeup frame6 within offset 12 to 75</b>
00D3h	R/W	LSBCRC7	<b>LSB of the mask byte of wakeup frame7 within offset 12 to 75</b>
00D4h-00D7h	-	-	<b>Reserved</b>
00D8h	R/W	Config5	<b>Configuration register 5</b>
00D9h-00FFh	-	-	<b>Reserved</b>

## 5.1 Receive Status Register in Rx packet header

Bit	R/W	Symbol	Description
15	R	MAR	<b>Multicast Address Received:</b> This bit set to 1 indicates that a multicast packet is received.
14	R	PAM	<b>Physical Address Matched:</b> This bit set to 1 indicates that the destination address of this packet matches the value written in ID registers.
13	R	BAR	<b>Broadcast Address Received:</b> This bit set to 1 indicates that a broadcast packet is received. BAR, MAR bit will not be set simultaneously.
12-6	-	-	<b>Reserved</b>
5	R	ISE	<b>Invalid Symbol Error: (100BASE-TX only)</b> This bit set to 1 indicates that an invalid symbol was encountered during the reception of this packet.
4	R	RUNT	<b>Runt Packet Received:</b> This bit set to 1 indicates that the received packet length is smaller than 64 bytes ( i.e. media header + data + CRC < 64 bytes )
3	R	LONG	<b>Long Packet:</b> This bit set to 1 indicates that the size of the received packet exceeds 4k bytes.
2	R	CRC	<b>CRC Error:</b> When set, indicates that a CRC error occurred on the received packet.
1	R	FAE	<b>Frame Alignment Error:</b> When set, indicates that a frame alignment error occurred on this received packet.
0	R	ROK	<b>Receive OK:</b> When set, indicates that a good packet is received.

## 5.2 Transmit Status Register (TSD0-3)(Offset 0010h-001Fh, R/W)

The read-only bits (CRS, TABT, OWC, CDH, NCC3-0, TOK, TUN) will be cleared by the RTL8100B(L) when the Transmit Byte Count (bits 12-0) in the corresponding Tx descriptor is written. It is not affected when software writes to these bits. These registers are only permitted to write by double-word access. After a software reset, all bits except OWN bit are reset to "0".

Bit	R/W	Symbol	Description
31	R	CRS	<b>Carrier Sense Lost:</b> This bit is set to 1 when the carrier is lost during transmission of a packet.
30	R	TABT	<b>Transmit Abort:</b> This bit is set to 1 if the transmission of a packet was aborted. This bit is read only, writing to this bit is not affected.
29	R	OWC	<b>Out of Window Collision:</b> This bit is set to 1 if the RTL8100B(L) encountered an "out of window" collision during the transmission of a packet.
28	R	CDH	<b>CD Heart Beat:</b> The NIC watches for a collision signal (ie, CD Heartbeat signal) during the first 6.4us of the interframe gap following a transmission. This bit is set if the transceiver fails to send this signal. This bit is cleared in the 100 Mbps mode.
27-24	R	NCC3-0	<b>Number of Collision Count:</b> Indicates the number of collisions encountered during the transmission of a packet.
23-22	-	-	<b>Reserved</b>
21-16	R/W	ERTXTH5-0	<b>Early Tx Threshold:</b> Specifies the threshold level in the Tx FIFO to begin the transmission. When the byte count of the data in the Tx FIFO reaches this level, (or the FIFO contains at least one complete packet) the RTL8100B(L) will transmit this packet. 000000 = 8 bytes These fields count from 000001 to 111111 in unit of 32 bytes. This threshold must be avoided from exceeding 2K byte.
15	R	TOK	<b>Transmit OK:</b> Set to 1 indicates that the transmission of a packet was completed successfully and no transmit underrun has occurred.
14	R	TUN	<b>Transmit FIFO Underrun:</b> Set to 1 if the Tx FIFO was exhausted during the transmission of a packet. The RTL8100B(L) can re-transfer data if the Tx FIFO underruns and can also transmit the packet to the wire successfully even though the Tx FIFO underruns. That is, when TSD<TUN>=1, TSD<TOK>=0 and ISR<TOK>=1 (or ISR<TER>=1).
13	R/W	OWN	<b>OWN:</b> The RTL8100B(L) sets this bit to 1 when the Tx DMA operation of this descriptor was completed. The driver must set this bit to 0 when the Transmit Byte Count (bits 0-12) is written. The default value is 1.
12-0	R/W	SIZE	<b>Descriptor Size:</b> The total size in bytes of the data in this descriptor. If the packet length is more than 1792 byte (0700h), the Tx queue will be invalid, i.e. the next descriptor will be written only after the OWN bit of that long packet's descriptor has been set.

### 5.3 ERSR: Early Rx Status Register (Offset 0036h, R)

Bit	R/W	Symbol	Description
7-4	-	-	<b>Reserved</b>
3	R	ERGood	<b>Early Rx Good packet:</b> This bit is set whenever a packet is completely received and the packet is good. Writing a 1 to this bit will clear it.
2	R	ERBad	<b>Early Rx Bad packet:</b> This bit is set whenever a packet is completely received and the packet is bad. Writing a 1 to this bit will clear it.
1	R	EROVW	<b>Early Rx OverWrite:</b> This bit is set when the RTL8100B(L)'s local address pointer is equal to CAPR. In the early mode, this is different from buffer overflow. It happens that the RTL8100B(L) detected an Rx error and wanted to fill another packet data from the beginning address of that error packet. Writing a 1 to this bit will clear it.
0	R	EROK	<b>Early Rx OK:</b> The power-on value is 0. It is set when the Rx byte count of the arriving packet exceeds the Rx threshold. After the whole packet is received, the RTL8100B(L) will set ROK or RER in ISR and clear this bit simultaneously. Setting this bit will invoke a ROK interrupt.

### 5.4 Command Register (Offset 0037h, R/W)

This register is used for issuing commands to the RTL8100B(L). These commands are issued by setting the corresponding bits for the function. A global software reset along with individual reset and enable/disable for transmitter and receiver are provided here.

Bit	R/W	Symbol	Description
7-5	-	-	<b>Reserved</b>
4	R/W	RST	<b>Reset:</b> Setting to 1 forces the RTL8100B(L) to a software reset state which disables the transmitter and receiver, reinitializes the FIFOs, resets the system buffer pointer to the initial value (Tx buffer is at TSAD0, Rx buffer is empty). The values of IDR0-5 and MAR0-7 and PCI configuration space will have no changes. This bit is 1 during the reset operation, and is cleared to 0 by the RTL8100B(L) when the reset operation is complete.
3	R/W	RE	<b>Receiver Enable:</b> When set to 1, and the receive state machine is idle, the receive machine becomes active. This bit will read back as a 1 whenever the receive state machine is active. After initial power-up, software must insure that the receiver has completely reset before setting this bit. This bit will be reset after PCI reset deassertion.
2	R/W	TE	<b>Transmitter Enable:</b> When set to 1, and the transmit state machine is idle, then the transmit state machine becomes active. This bit will read back as a 1 whenever the transmit state machine is active. After initial power-up, software must insure that the transmitter has completely reset before setting this bit. This bit will be reset after PCI reset deassertion.
1	-	-	<b>Reserved</b>
0	R	BUFE	<b>Buffer Empty:</b> Rx Buffer Empty. There is no packet stored in the Rx buffer ring.

## 5.5 Interrupt Mask Register (Offset 003Ch-003Dh, R/W)

This register masks the interrupts that can be generated from the Interrupt Status Register. A hardware reset will clear all mask bits. Setting a mask bit allows the corresponding bit in the Interrupt Status Register to cause an interrupt. The Interrupt Status Register bits are always set to 1 if the condition is present, regardless of the state of the corresponding mask bit.

Bit	R/W	Symbol	Description
15	R/W	SERR	<b>System Error Interrupt:</b> 1 => Enable, 0 => Disable.
14	R/W	TimeOut	<b>Time Out Interrupt:</b> 1 => Enable, 0 => Disable.
13	R/W	LenChg	<b>Cable Length Change Interrupt:</b> 1 => Enable, 0 => Disable.
12-7	-	-	<b>Reserved</b>
6	R/W	FOVW	<b>Rx FIFO Overflow Interrupt:</b> 1 => Enable, 0 => Disable.
5	R/W	PUN/LinkChg	<b>Packet Underrun/Link Change Interrupt:</b> 1 => Enable, 0 => Disable.
4	R/W	RXOVW	<b>Rx Buffer Overflow Interrupt:</b> 1 => Enable, 0 => Disable.
3	R/W	TER	<b>Transmit Error Interrupt:</b> 1 => Enable, 0 => Disable.
2	R/W	TOK	<b>Transmit OK Interrupt:</b> 1 => Enable, 0 => Disable.
1	R/W	RER	<b>Receive Error Interrupt:</b> 1 => Enable, 0 => Disable.
0	R/W	ROK	<b>Receive OK Interrupt:</b> 1 => Enable, 0 => Disable.

## 5.6 Interrupt Status Register (Offset 003Eh-003Fh, R/W)

This register indicates the source of an interrupt when the INTA pin goes active. Enabling the corresponding bits in the Interrupt Mask Register (IMR) allows bits in this register to produce an interrupt. When an interrupt is active, one of more bits in this register are set to a “1”. The interrupt Status Register reflects all current pending interrupts, regardless of the state of the corresponding mask bit in the IMR. Reading the ISR clears all interrupts. Writing to the ISR has no effect.

Bit	R/W	Symbol	Description
15	R/W	SERR	<b>System Error:</b> Set to 1 when the RTL8100B(L) signals a system error on the PCI bus.
14	R/W	TimeOut	<b>Time Out:</b> Set to 1 when the TCTR register reaches to the value of the TimerInt register.
13	R/W	LenChg	<b>Cable Length Change:</b> Cable length is changed after Receiver is enabled.
12 - 7	-	-	<b>Reserved</b>
6	R/W	FOVW	<b>Rx FIFO Overflow:</b> Set when an overflow occurs on the Rx status FIFO.
5	R/W	PUN/LinkChg	<b>Packet Underrun/Link Change:</b> Set to 1 when CAPR is written but Rx buffer is empty, or when link status is changed.
4	R/W	RXOVW	<b>Rx Buffer Overflow:</b> Set when receive (Rx) buffer ring storage resources have been exhausted.
3	R/W	TER	<b>Transmit (Tx) Error:</b> Indicates that a packet transmission was aborted, due to excessive collisions, according to the TXRR's setting.
2	R/W	TOK	<b>Transmit (Tx) OK:</b> Indicates that a packet transmission is completed successfully.
1	R/W	RER	<b>Receive (Rx) Error:</b> Indicates that a packet has either CRC error or frame alignment error (FAE). The collided frame will not be recognized as CRC error if the length of this frame is shorter than 16 byte.
0	R/W	ROK	<b>Receive (Rx) OK:</b> In normal mode, indicates the successful completion of a packet reception. In early mode, indicates that the Rx byte count of the arriving packet exceeds the early Rx threshold.

## 5.7 Transmit Configuration Register (Offset 0040h-0043h, R/W)

This register defines the Transmit Configuration for the RTL8100B(L). It controls such functions as Loopback, programmable Interframe Gap, Fill and Drain Thresholds, and maximum DMA burst size.

Bit	R/W	Symbol	Description																																																																																																
31	-	-	<b>Reserved</b>																																																																																																
30-26	R	HWVERID_A	<b>Hardware Version ID A:</b> <table border="1" style="margin-left: 20px;"> <thead> <tr> <th></th> <th>Bit30</th> <th>Bit29</th> <th>Bit28</th> <th>Bit27</th> <th>Bit26</th> <th>Bit23</th> <th>Bit22</th> </tr> </thead> <tbody> <tr> <td>RTL8139</td> <td>1</td> <td>1</td> <td>0</td> <td>0</td> <td>0</td> <td>0</td> <td>0</td> </tr> <tr> <td>RTL8139A</td> <td>1</td> <td>1</td> <td>1</td> <td>0</td> <td>0</td> <td>0</td> <td>0</td> </tr> <tr> <td>RTL8139A-G</td> <td>1</td> <td>1</td> <td>1</td> <td>0</td> <td>1</td> <td>0</td> <td>0</td> </tr> <tr> <td>RTL8139B</td> <td>1</td> <td>1</td> <td>1</td> <td>1</td> <td>0</td> <td>0</td> <td>0</td> </tr> <tr> <td>RTL8130</td> <td>1</td> <td>1</td> <td>1</td> <td>1</td> <td>0</td> <td>0</td> <td>0</td> </tr> <tr> <td>RTL8139C</td> <td>1</td> <td>1</td> <td>1</td> <td>0</td> <td>1</td> <td>0</td> <td>0</td> </tr> <tr> <td>RTL8100</td> <td>1</td> <td>1</td> <td>1</td> <td>1</td> <td>0</td> <td>1</td> <td>0</td> </tr> <tr> <td>RTL8100B/ 8139D</td> <td>1</td> <td>1</td> <td>1</td> <td>0</td> <td>1</td> <td>0</td> <td>1</td> </tr> <tr> <td>RTL8139C+</td> <td>1</td> <td>1</td> <td>1</td> <td>0</td> <td>1</td> <td>1</td> <td>0</td> </tr> <tr> <td>RTL8101</td> <td>1</td> <td>1</td> <td>1</td> <td>0</td> <td>1</td> <td>1</td> <td>1</td> </tr> <tr> <td>Reserved</td> <td colspan="7">Other combination</td> </tr> </tbody> </table>		Bit30	Bit29	Bit28	Bit27	Bit26	Bit23	Bit22	RTL8139	1	1	0	0	0	0	0	RTL8139A	1	1	1	0	0	0	0	RTL8139A-G	1	1	1	0	1	0	0	RTL8139B	1	1	1	1	0	0	0	RTL8130	1	1	1	1	0	0	0	RTL8139C	1	1	1	0	1	0	0	RTL8100	1	1	1	1	0	1	0	RTL8100B/ 8139D	1	1	1	0	1	0	1	RTL8139C+	1	1	1	0	1	1	0	RTL8101	1	1	1	0	1	1	1	Reserved	Other combination						
	Bit30	Bit29	Bit28	Bit27	Bit26	Bit23	Bit22																																																																																												
RTL8139	1	1	0	0	0	0	0																																																																																												
RTL8139A	1	1	1	0	0	0	0																																																																																												
RTL8139A-G	1	1	1	0	1	0	0																																																																																												
RTL8139B	1	1	1	1	0	0	0																																																																																												
RTL8130	1	1	1	1	0	0	0																																																																																												
RTL8139C	1	1	1	0	1	0	0																																																																																												
RTL8100	1	1	1	1	0	1	0																																																																																												
RTL8100B/ 8139D	1	1	1	0	1	0	1																																																																																												
RTL8139C+	1	1	1	0	1	1	0																																																																																												
RTL8101	1	1	1	0	1	1	1																																																																																												
Reserved	Other combination																																																																																																		
25-24	R/W	IFG1, 0	<b>Interframe Gap Time:</b> This field allows the user to adjust the interframe gap time below the standard: 9.6 $\mu$ s for 10Mbps, 960 ns for 100Mbps. The time can be programmed from 9.6 $\mu$ s to 8.4 $\mu$ s (10Mbps) and 960ns to 840ns (100Mbps). Note that any value other than (1, 1) will violate the IEEE 802.3 standard. The formula for the inter frame gap is: 10 Mbps <span style="float: right;">8.4<math>\mu</math>s + 0.4(IFG(1:0)) <math>\mu</math>s</span> 100 Mbps <span style="float: right;">840ns + 40(IFG(1:0)) ns</span>																																																																																																
23-22	R	HWVERID_B	<b>Hardware Version ID B</b>																																																																																																
21-19	-	-	<b>Reserved</b>																																																																																																
18, 17	R/W	LBK1, LBK0	<b>Loopback test:</b> There will be no packet on the TX+/- lines under the Loopback test condition. The loopback function must be independent of the link state. 00 : normal operation 01 : Reserved 10 : Reserved 11 : Loopback mode																																																																																																
16	R/W	CRC	<b>Append CRC:</b> Setting to 1 means that there is no CRC appended at the end of a packet. Setting to 0 means that there is CRC appended at the end of a packet.																																																																																																
15-11	-	-	<b>Reserved</b>																																																																																																
10-8	R/W	MXDMA2, 1, 0	<b>Max DMA Burst Size per Tx DMA Burst:</b> This field sets the maximum size of transmit DMA data bursts according to the following table: 000 = 16 bytes 001 = 32 bytes 010 = 64 bytes 011 = 128 bytes 100 = 256 bytes 101 = 512 bytes 110 = 1024 bytes 111 = 2048 bytes																																																																																																



7-4	R/W	TXRR	<p><b>Tx Retry Count:</b> These are used to specify additional transmission retries in multiple of 16 (IEEE 802.3 CSMA/CD retry count). If the TXRR is set to 0, the transmitter will re-transmit 16 times before aborting due to excessive collisions. If the TXRR is set to a value greater than 0, the transmitter will re-transmit a number of times equals to the following formula before aborting:</p> $\text{Total retries} = 16 + (\text{TXRR} * 16)$ <p>The TER bit in the ISR register or transmit descriptor will be set when the transmission fails and reaches to this specified retry count.</p>
3-1	-	-	<b>Reserved</b>
0	W	CLRABT	<p><b>Clear Abort:</b> Setting this bit to 1 causes the RTL8100B(L) to retransmit the packet at the last transmitted descriptor when this transmission was aborted, Setting this bit is only permitted in the transmit abort state.</p>

## 5.8 Receive Configuration Register (Offset 0044h-0047h, R/W)

This register is used to set the receive configuration for the RTL8100B(L). Receive properties such as accepting error packets, runt packets, setting the receive drain threshold etc. are controlled here.

Bit	R/W	Symbol	Description																
31-28	-	-	<b>Reserved</b>																
27-24	R/W	ERTH3, 2, 1, 0	<p><b>Early Rx threshold bits:</b> These bits are used to select the Rx threshold multiplier of the whole packet that has been transferred to the system buffer in early mode when the frame protocol is under the RTL8100B(L)'s definition.</p> <table border="0"> <tr> <td>0000 = no early Rx threshold</td> <td>0001 = 1/16</td> </tr> <tr> <td>0010 = 2/16</td> <td>0011 = 3/16</td> </tr> <tr> <td>0100 = 4/16</td> <td>0101 = 5/16</td> </tr> <tr> <td>0110 = 6/16</td> <td>0111 = 7/16</td> </tr> <tr> <td>1000 = 8/16</td> <td>1001 = 9/16</td> </tr> <tr> <td>1010 = 10/16</td> <td>1011 = 11/16</td> </tr> <tr> <td>1100 = 12/16</td> <td>1101 = 13/16</td> </tr> <tr> <td>1110 = 14/16</td> <td>1111 = 15/16</td> </tr> </table>	0000 = no early Rx threshold	0001 = 1/16	0010 = 2/16	0011 = 3/16	0100 = 4/16	0101 = 5/16	0110 = 6/16	0111 = 7/16	1000 = 8/16	1001 = 9/16	1010 = 10/16	1011 = 11/16	1100 = 12/16	1101 = 13/16	1110 = 14/16	1111 = 15/16
0000 = no early Rx threshold	0001 = 1/16																		
0010 = 2/16	0011 = 3/16																		
0100 = 4/16	0101 = 5/16																		
0110 = 6/16	0111 = 7/16																		
1000 = 8/16	1001 = 9/16																		
1010 = 10/16	1011 = 11/16																		
1100 = 12/16	1101 = 13/16																		
1110 = 14/16	1111 = 15/16																		
23-18	-	-	<b>Reserved</b>																
17	R/W	MuLERINT	<p><b>Multiple early interrupt select:</b> When this bit is set, any received packet invokes early interrupt according to MULINT&lt;MISR[11:0]&gt; setting in early mode. When this bit is reset, the packets of familiar protocols (IPX, IP, NDIS, etc) invoke early interrupt according to RCR&lt;ERTH[3:0]&gt; setting in early mode. The packets of unfamiliar protocols will invoke early interrupt according to the setting of MULINT&lt;MISR[11:0]&gt;.</p>																
16	R/W	RER8	<p>The RTL8100B(L) receives the error packet whose length is larger than 8 bytes after setting the RER8 bit to 1.</p> <p>The RTL8100B(L) receives the error packet larger than 64-byte long when the RER8 bit is cleared. The power-on default is zero.</p> <p>If AER or AR is set, the RER will be set when the RTL8100B(L) receives an error packet whose length is larger than 8 bytes. The RER8 is "Don't care" in this situation.</p>																

15-13	R/W	RXFTH2, 1, 0	<p><b>Rx FIFO Threshold:</b> Specifies Rx FIFO Threshold level. When the number of the received data bytes from a packet, which is being received into the RTL8100B(L)'s Rx FIFO, has reached to this level (or the FIFO has contained a complete packet), the receive PCI bus master function will begin to transfer the data from the FIFO to the host memory. This field sets the threshold level according to the following table:</p> <p>000 = 16 bytes  001 = 32 bytes  010 = 64 bytes  011 = 128 bytes  100 = 256 bytes  101 = 512 bytes  110 = 1024 bytes  111 = No Rx threshold. The RTL8100B(L) begins the transfer of data after having received a whole packet in the FIFO.</p>
12-11	R/W	RBLLEN1, 0	<p><b>Rx Buffer Length:</b> This field indicates the size of the Rx ring buffer.</p> <p>00 = 8k + 16 byte  01 = 16k + 16 byte  10 = 32K + 16 byte  11 = 64K + 16 byte</p>
10-8	R/W	MXDMA2, 1, 0	<p><b>Max DMA Burst Size per Rx DMA Burst:</b> This field sets the maximum size of the receive DMA data bursts according to the following table:</p> <p>000 = 16 bytes  001 = 32 bytes  010 = 64 bytes  011 = 128 bytes  100 = 256 bytes  101 = 512 bytes  110 = 1024 bytes  111 = Unlimited</p>
7	R/W	WRAP	<p>When set to 0: The RTL8100B(L) will transfer the rest of the packet data into the beginning of the Rx buffer if this packet has not been completely moved into the Rx buffer and the transfer has arrived at the end of the Rx buffer.</p> <p>When set to 1: The RTL8100B(L) will keep moving the rest of the packet data into the memory immediately after the end of the Rx buffer, if this packet has not been completely moved into the Rx buffer and the transfer has arrived at the end of the Rx buffer. The software driver must reserve at least 1.5K bytes buffer to accept the remainder of the packet. We assume that the remainder of the packet is X bytes. The next packet will be moved into the memory from the X byte offset at the top of the Rx buffer.</p> <p>This bit is invalid when Rx buffer is selected to 64K bytes.</p>
6	-	-	<b>Reserved</b>
5	R/W	AER	<p><b>Accept Error Packet:</b> When set to 1, all packets with CRC error, alignment error, and/or collided fragments will be accepted. When set to 0, all packets with CRC error, alignment error, and/or collided fragments will be rejected.</p>
4	R/W	AR	<p><b>Accept Runt:</b> This bit allows the receiver to accept packets that are smaller than 64 bytes. The packet must be at least 8 bytes long to be accepted as a runt. Set to 1 to accept runt packets.</p>
3	R/W	AB	<p><b>Accept Broadcast packets:</b> Set to 1 to accept, 0 to reject.</p>
2	R/W	AM	<p><b>Accept Multicast packets:</b> Set to 1 to accept, 0 to reject.</p>
1	R/W	APM	<p><b>Accept Physical Match packets:</b> Set to 1 to accept, 0 to reject.</p>
0	R/W	AAP	<p><b>Accept All Packets:</b> Set to 1 to accept all packets with a physical destination address, 0 to reject.</p>

## 5.9 9346CR: 93C46 Command Register (Offset 0050h, R/W)

This register is used for issuing commands to the RTL8100B(L). These commands are issued by setting the corresponding bits for the function. A warm software reset along with individual reset and enable/disable for transmitter and receiver are provided as well.

Bit	R/W	Symbol	Description															
7-6	R/W	EEM1-0	<p><b>Operating Mode:</b> These 2 bits select the RTL8100B(L) operating mode.</p> <table border="1"> <thead> <tr> <th>EEM1</th> <th>EEM0</th> <th>Operating Mode</th> </tr> </thead> <tbody> <tr> <td>0</td> <td>0</td> <td><b>Normal:</b> RTL8100B(L) network/host communication mode.</td> </tr> <tr> <td>0</td> <td>1</td> <td><b>Auto-load:</b> Entering this mode will make the RTL8100B(L) load the contents of 93C46 like when the RSTB signal is asserted. This auto-load operation will take about 2 ms. After it is completed, the RTL8100B(L) goes back to the normal mode automatically (EEM1 = EEM0 = 0) and all the other registers are reset to default values.</td> </tr> <tr> <td>1</td> <td>0</td> <td><b>93C46 Programming:</b> In this mode, both network and host bus master operations are disabled. The 93C46 can be directly accessed via bit3-0 which now reflect the states of EECS, EESK, EEDI, &amp; EEDO pins respectively.</td> </tr> <tr> <td>1</td> <td>1</td> <td><b>Config Register Write Enable:</b> Before writing to CONFIG0, 1, 3, 4 registers, and bit13, 12, 8 of BMCR(offset 62h-63h), the RTL8100B(L) must be placed in this mode. This will prevent RTL8100B(L)'s configurations from accidental change.</td> </tr> </tbody> </table>	EEM1	EEM0	Operating Mode	0	0	<b>Normal:</b> RTL8100B(L) network/host communication mode.	0	1	<b>Auto-load:</b> Entering this mode will make the RTL8100B(L) load the contents of 93C46 like when the RSTB signal is asserted. This auto-load operation will take about 2 ms. After it is completed, the RTL8100B(L) goes back to the normal mode automatically (EEM1 = EEM0 = 0) and all the other registers are reset to default values.	1	0	<b>93C46 Programming:</b> In this mode, both network and host bus master operations are disabled. The 93C46 can be directly accessed via bit3-0 which now reflect the states of EECS, EESK, EEDI, & EEDO pins respectively.	1	1	<b>Config Register Write Enable:</b> Before writing to CONFIG0, 1, 3, 4 registers, and bit13, 12, 8 of BMCR(offset 62h-63h), the RTL8100B(L) must be placed in this mode. This will prevent RTL8100B(L)'s configurations from accidental change.
EEM1	EEM0	Operating Mode																
0	0	<b>Normal:</b> RTL8100B(L) network/host communication mode.																
0	1	<b>Auto-load:</b> Entering this mode will make the RTL8100B(L) load the contents of 93C46 like when the RSTB signal is asserted. This auto-load operation will take about 2 ms. After it is completed, the RTL8100B(L) goes back to the normal mode automatically (EEM1 = EEM0 = 0) and all the other registers are reset to default values.																
1	0	<b>93C46 Programming:</b> In this mode, both network and host bus master operations are disabled. The 93C46 can be directly accessed via bit3-0 which now reflect the states of EECS, EESK, EEDI, & EEDO pins respectively.																
1	1	<b>Config Register Write Enable:</b> Before writing to CONFIG0, 1, 3, 4 registers, and bit13, 12, 8 of BMCR(offset 62h-63h), the RTL8100B(L) must be placed in this mode. This will prevent RTL8100B(L)'s configurations from accidental change.																
4-5	-	-	<b>Reserved</b>															
3	R/W	EECS	These bits reflect the state of EECS, EESK, EEDI & EEDO pins in auto-load or 93C46 programming mode.															
2	R/W	EESK																
1	R/W	EEDI																
0	R	EEDO																

## 5.10 CONFIG 0: Configuration Register 0 (Offset 0051h, R/W)

Bit	R/W	Symbol	Description
7	R	SCR	<b>Scrambler Mode:</b> Always 0.
6	R	PCS	<b>PCS Mode:</b> Always 0.
5	R	T10	<b>10 Mbps Mode:</b> Always 0.
4-3	R	PL1, PL0	<b>Select 10 Mbps medium type:</b> Always (PL1, PL0) = (1, 0)
2-0	-	-	<b>Reserved</b>

## 5.11 CONFIG 1: Configuration Register 1 (Offset 0052h, R/W)

Bit	R/W	Symbol	Description													
7-6	R/W	LEDS1-0	Refer to the LED PIN definition. The initial value of these bits comes from the 93C46.													
5	R/W	DVRLOAD	<b>Driver Load:</b> Software may use this bit to make sure that the driver has been loaded. Writing 1 is 1. Writing 0 is 0. When the command register bits IOEN, MEMEN, and BMEN of the PCI configuration space are written, the RTL8100B(L) will clear this bit automatically.													
4	R/W	LWACT	<p><b>LWAKE active mode:</b> The LWACT bit and LWPTN bit in CONFIG4 register are used to program the LWAKE pin's output signal. According to the combination of these two bits, there may be 4 choices of LWAKE signal, i.e., active high, active low, positive (high) pulse, and negative (low) pulse. The output pulse width is about 150 ms.</p> <p>The default value of each of these two bits is 0, i.e., the default output signal of LWAKE pin is an active high signal.</p> <table border="1" style="margin-left: auto; margin-right: auto;"> <thead> <tr> <th colspan="2" rowspan="2">LWAKE output</th> <th colspan="2">LWACT</th> </tr> <tr> <th>0</th> <th>1</th> </tr> </thead> <tbody> <tr> <th rowspan="2">LWPTN</th> <td>0</td> <td>Active high*</td> <td>Active low</td> </tr> <tr> <td>1</td> <td>Positive pulse</td> <td>Negative pulse</td> </tr> </tbody> </table> <p>* Default value.</p>	LWAKE output		LWACT		0	1	LWPTN	0	Active high*	Active low	1	Positive pulse	Negative pulse
LWAKE output		LWACT														
		0	1													
LWPTN	0	Active high*	Active low													
	1	Positive pulse	Negative pulse													
3	R	MEMMAP	<b>Memory Mapping:</b> The operational registers are mapped into PCI memory space.													
2	R	IOMAP	<b>I/O Mapping:</b> The operational registers are mapped into PCI I/O space.													
1	R/W	VPD	<b>Set to enable Vital Product Data:</b> The VPD data is stored in 93C46 from within offset 40h-7Fh.													
0	R/W	PMEn	<p><b>Power Management Enable:</b>            Writable only when 93C46CR register EEM1=EEM0=1            Let A denote the New_Cap bit (bit 4 of the Status Register) in the PCI Configuration space offset 06H.            Let B denote the Cap_Ptr register in the PCI Configuration space offset 34H.            Let C denote the Cap_ID (power management) register in the PCI Configuration space offset 50H.            Let D denote the power management registers in the PCI Configuration space offset from 52H to 57H.            Let E denote the Next_Ptr (power management) register in the PCI Configuration space offset 51H.</p> <p><b>PMEn Description</b></p> <p>1 A=1, B=50h, C=01h, D valid, E=0            0 A=B=C=E=0, D not valid</p>													

## 5.12 Media Status Register (Offset 0058h, R/W)

This register allows configuration of device and PHY options, and provides PHY status information.

Bit	R/W	Symbol	Description																		
7	R/W	TXFCE/ LdTXFCE	<p><b>Tx Flow Control Enable:</b> The flow control is valid in full-duplex mode only. This register's default value comes from 93C46.</p> <table border="1"> <thead> <tr> <th>RTL8100B(L)</th> <th>Remote</th> <th>TXFCE/LdTXFCE</th> </tr> </thead> <tbody> <tr> <td>ANE = 1</td> <td>NWAY FLY mode</td> <td>R/O</td> </tr> <tr> <td>ANE = 1</td> <td>NWAY mode only</td> <td>R/W</td> </tr> <tr> <td>ANE = 1</td> <td>No NWAY</td> <td>R/W</td> </tr> <tr> <td>ANE = 0 &amp; full-duplex mode</td> <td>-</td> <td>R/W</td> </tr> <tr> <td>ANE = 0 &amp; half-duplex mode</td> <td>-</td> <td>invalid</td> </tr> </tbody> </table> <p>NWAY FLY mode : NWAY with flow control capability            NWAY mode only : NWAY without flow control capability</p>	RTL8100B(L)	Remote	TXFCE/LdTXFCE	ANE = 1	NWAY FLY mode	R/O	ANE = 1	NWAY mode only	R/W	ANE = 1	No NWAY	R/W	ANE = 0 & full-duplex mode	-	R/W	ANE = 0 & half-duplex mode	-	invalid
RTL8100B(L)	Remote	TXFCE/LdTXFCE																			
ANE = 1	NWAY FLY mode	R/O																			
ANE = 1	NWAY mode only	R/W																			
ANE = 1	No NWAY	R/W																			
ANE = 0 & full-duplex mode	-	R/W																			
ANE = 0 & half-duplex mode	-	invalid																			
6	R/W	RXFCE	<b>RX Flow control Enable:</b> The flow control is enabled in full-duplex mode only. The default value comes from 93C46.																		
5	-	-	<b>Reserved</b>																		
4	R	Aux_Status	<p><b>Aux. Power present Status:</b>            1: The Aux. Power is present.            0: The Aux. Power is absent.            The value of this bit is fixed after each PCI reset.</p>																		
3	R	SPEED_10	<b>Speed:</b> Set, when current media is 10 Mbps mode. Reset, when current media is 100 Mbps mode.																		
2	R	LINKB	Inverse of Link status. 0 = Link OK. 1 = Link Fail.																		
1	R	TXPF	Set, when RTL8100B(L) sends pause packet. Reset, when RTL8100B(L) sends timer done packet.																		
0	R	RXPF	<b>Pause Flag:</b> Set, when RTL8100B(L) is in backoff state because a pause packet received. Reset, when pause state is clear.																		

### 5.13 CONFIG 3: Configuration Register3 (Offset 0059h, R/W)

Bit	R/W	Symbol	Description
7	R	GNTSel	<p><b>Gnt Select:</b> Select the Frame's asserted time after the Grant signal has been asserted. The Frame and Grant are the PCI signals.</p> <p>1: delay one clock from GNT assertion. 0: No delay</p>
6	R/W	PARM_En	<p><b>Parameter Enable:</b> (Used in 100Mbps mode only)</p> <p>This set to 0 and the 9346CR register EEM1=EEM0=1 will enable the PHY1_PARM, PHY2_PARM, and TW_PARM registers to be written via software.</p> <p>This set to 1 will allow parameters to be auto-loaded from the 93C46 and disable writing to the PHY1_PARM, PHY2_PARM and TW_PARM registers via software.</p> <p>The PHY1_PARM and PHY2_PARM can be auto-loaded from the EEPROM in this mode. The parameter auto-load process is executed every time the Link is OK in 100Mbps mode.</p>
5	R/W	Magic	<p><b>Magic Packet:</b> This bit is valid when the PWEn bit of the CONFIG1 register is set. The RTL8100B(L) will assert the PMEB signal to wakeup the operating system when the Magic Packet is received.</p> <p>Once the RTL8100B(L) has been enabled for Magic Packet wakeup and has been put into adequate state, it scans all incoming packets addressed to the node for a specific data sequence, which indicates to the controller that this is a Magic Packet frame. A Magic Packet frame must also meet the basic requirements of:</p> <p>Destination address + Source address + data + CRC</p> <p>The destination address may be the node ID of the receiving station or a multicast address, which includes the broadcast address.</p> <p>The specific sequence consists of 16 duplications of 6 byte ID registers, with no breaks or interrupts. This sequence can be located anywhere within the packet, but must be preceded by a synchronization stream, 6 bytes of FFh. The device will also accept a multicast address, as long as the 16 duplications of the IEEE address match the address of the ID registers.</p> <p>If the Node ID is 11h 22h 33h 44h 55h 66h, then the magic frame's format is similar to the following:</p> <p>Destination address + source address + MISC + FF FF FF FF FF FF + MISC + 11 22 33 44 55 66 + 11 22 33 44 55 66 + 11 22 33 44 55 66 + 11 22 33 44 55 66 + 11 22 33 44 55 66 + 11 22 33 44 55 66 + 11 22 33 44 55 66 + 11 22 33 44 55 66 + 11 22 33 44 55 66 + 11 22 33 44 55 66 + 11 22 33 44 55 66 + 11 22 33 44 55 66 + 11 22 33 44 55 66 + MISC + CRC</p>
4	R/W	LinkUp	<p><b>Link Up:</b> This bit is valid when the PWEn bit of CONFIG1 register is set. The RTL8100B(L), in adequate power state, will assert the PMEB signal to wakeup the operating system when the cable connection is re-established.</p>
3-1	-	-	<b>Reserved</b>
0	R	FBtBEn	<p><b>Fast Back to Back Enable:</b> Set to 1 to enable Fast Back to Back.</p>

## 5.14 CONFIG 4: Configuration Register4 (Offset 005Ah, R/W)

Bit	R/W	Symbol	Description
7	R/W	RxFIFOAutoClr	Set to 1, the RTL8100B(L) will clear the Rx FIFO overflow automatically.
6	R/W	AnaOff	<b>Analog Power Off:</b> This bit can not be auto-loaded from EEPROM (93C46). 1: Turn off the analog power of the RTL8100B(L) internally. 0: Normal working state. This is also power-on default value.
5	R/W	LongWF	<b>Long Wake-up Frame:</b> The initial value comes from EEPROM autoloading. Set to 0: The RTL8100B(L) supports up to 8 wake-up frames, each with masked bytes selected from offset 12 to 75. Set to 1: The RTL8100B(L) supports up to 5 wake-up frames, each with 16-bit CRC algorithm for MS Wakeup Frame, the low byte of 16-bit CRC should be placed at the correspondent CRC register, and the high byte of 16-bit CRC should be placed at the correspondent LSBCRC register. The wake-up frame 0 and 1 are the same as above, except that the masked bytes start from offset 0 to 63. The wake-up frame 2 and 3 are merged into one long wake-up frame respectively with masked bytes selected from offset 0 to 127. The wake-up frame 4 and 5, 6 and 7 are merged respectively into another 2 long wake-up frames. Please refer to 7.4 PCI Power Management functions for a detailed description.
4	R/W	LWPME	<b>LANWAKE vs PMEB:</b> Set to 1: The LWAKE can only be asserted when the PMEB is asserted and the ISOLATEB is low. Set to 0: The LWAKE and PMEB are asserted at the same time.
3	-	-	<b>Reserved</b>
2	R/W	LWPTN	<b>LWAKE pattern:</b> Please refer to LWACT bit in CONFIG1 register.
1	-	-	<b>Reserved</b>
0	R/W	PBWakeup	<b>Pre-Boot Wakeup:</b> The initial value comes from EEPROM autoloading. 1: Pre-Boot Wakeup disabled. (suitable for CardBus and MiniPCI applications) 0: Pre-Boot Wakeup enabled.

## 5.15 Multiple Interrupt Select Register (Offset 005Ch-005Dh, R/W)

If the received packet data is not a familiar protocol (IPX, IP, NDIS, etc.) to the RTL8100B(L), RCR<ERTH[3:0]> will not be used to transfer data in early mode. This register will be written to the received data length in order to make an early Rx interrupt for the unfamiliar protocol.

Bit	R/W	Symbol	Description
15-12	-	-	<b>Reserved</b>
11-0	R/W	MISR11-0	<b>Multiple Interrupt Select:</b> Indicates that the RTL8100B(L) makes an Rx interrupt after RTL8100B(L) has transferred the byte data into the system memory. If the value of these bits is zero, there will be no early interrupt as soon as the RTL8100B(L) prepares to execute the first PCI transaction of the received data. Bit1, 0 must be zero. The ERTH3-0 bits should not be set to 0 when the multiple interrupt select register is used.

- The above is true when MulERINT=0 (bit17, RCR). When MulERINT=1, any received packet invokes early interrupt according to MISR[11:0] setting in early mode.

## 5.16 PCI Revision ID (Offset 005Eh, R)

Bit	R/W	Symbol	Description
7-0	R	Revision ID	The value in PCI Configuration Space offset 08h is 10h.



## 5.17 Transmit Status of All Descriptors (TSAD) Register (Offset 0060h-0061h, R/W)

Bit	R/W	Symbol	Description
15	R	TOK3	TOK bit of Descriptor 3
14	R	TOK2	TOK bit of Descriptor 2
13	R	TOK1	TOK bit of Descriptor 1
12	R	TOK0	TOK bit of Descriptor 0
11	R	TUN3	TUN bit of Descriptor 3
10	R	TUN2	TUN bit of Descriptor 2
9	R	TUN1	TUN bit of Descriptor 1
8	R	TUN0	TUN bit of Descriptor 0
7	R	TABT3	TABT bit of Descriptor 3
6	R	TABT2	TABT bit of Descriptor 2
5	R	TABT1	TABT bit of Descriptor 1
4	R	TABT0	TABT bit of Descriptor 0
3	R	OWN3	OWN bit of Descriptor 3
2	R	OWN2	OWN bit of Descriptor 2
1	R	OWN1	OWN bit of Descriptor 1
0	R	OWN0	OWN bit of Descriptor 0

## 5.18 Basic Mode Control Register (Offset 0062h-0063h, R/W)

Bit	Name	Description/Usage	Default/Attribute
15	<b>Reset</b>	This bit sets the status and control registers of the PHY(register 0062-0074H) in a default state. This bit is self-clearing. 1 = software reset; 0 = normal operation.	0, RW
14	-	<b>Reserved</b>	-
13	<b>Spd_Set</b>	This bit sets the network speed. 1 = 100Mbps; 0 = 10Mbps. This bit's initial value comes from 93C46.	0, RW
12	<b>Auto Negotiation Enable (ANE)</b>	This bit enables/disables the NWay auto-negotiation function. Set to 1 to enable auto-negotiation, bit13 will be ignored. Set to 0 disables auto-negotiation, bit13 and bit8 will determine the link speed and the data transfer mode, respectively. This bit's initial value comes from 93C46.	0, RW
11-10	-	<b>Reserved</b>	-
9	<b>Restart Auto Negotiation</b>	This bit allows the NWay auto-negotiation function to be reset. 1 = re-start auto-negotiation; 0 = normal operation.	0, RW
8	<b>Duplex Mode</b>	This bit sets the duplex mode. 1 = full-duplex; 0 = normal operation. This bit's initial value comes from 93C46. If bit12 = 1, read = status write = register value. If bit12 = 0, read = write = register value.	0, RW
7-0	-	<b>Reserved</b>	-

## 5.19 Basic Mode Status Register (Offset 0064h-0065h, R)

Bit	Name	Description/Usage	Default/Attribute
15	<b>100Base-T4</b>	1 = enable 100Base-T4 support; 0 = suppress 100Base-T4 support.	0, RO
14	<b>100Base_TX_FD</b>	1 = enable 100Base-TX full duplex support; 0 = suppress 100Base-TX full duplex support.	1, RO
13	<b>100BASE_TX_H D</b>	1 = enable 100Base-TX half-duplex support; 0 = suppress 100Base-TX half-duplex support.	1, RO
12	<b>10Base_T_FD</b>	1 = enable 10Base-T full duplex support; 0 = suppress 10Base-T full duplex support.	1, RO
11	<b>10_Base_T_HD</b>	1 = enable 10Base-T half-duplex support; 0 = suppress 10Base-T half-duplex support.	1, RO
10-6	-	Reserved	-
5	<b>Auto Negotiation Complete</b>	1 = auto-negotiation process completed; 0 = auto-negotiation process not completed.	0, RO
4	<b>Remote Fault</b>	1 = remote fault condition detected (cleared on read); 0 = no remote fault condition detected.	0, RO
3	<b>Auto Negotiation</b>	1 = Link had not been experienced fail state. 0 = Link had been experienced fail state	1, RD
2	<b>Link Status</b>	1 = valid link established; 0 = no valid link established.	0, RO
1	<b>Jabber Detect</b>	1 = jabber condition detected; 0 = no jabber condition detected.	0, RO
0	<b>Extended Capability</b>	1 = extended register capability; 0 = basic register capability only.	1, RO

## 5.20 Auto-Negotiation Advertisement Register (Offset 0066h-0067h, R/W)

This register contains the advertised abilities of this device as they will be transmitted to its link partner during Auto-negotiation.

Bit	Name	Description/Usage	Default/Attribute
15	<b>NP</b>	Next Page bit. 1 = transmitting the protocol specific data page; 0 = transmitting the primary capability data page	0, RO
14	<b>ACK</b>	1 = acknowledge reception of link partner capability data word.	0, RO
13	<b>RF</b>	1 = advertise remote fault detection capability; 0 = do not advertise remote fault detection capability.	0, RW
12-11	-	Reserved	-
10	<b>Pause</b>	1 = flow control is supported by local node. 0 = flow control is not supported by local mode.	The default value comes from EEPROM, RO
9	<b>T4</b>	1 = 100Base-T4 is supported by local node; 0 = 100Base-T4 not supported by local node.	0, RO
8	<b>TXFD</b>	1 = 100Base-TX full duplex is supported by local node; 0 = 100Base-TX full duplex not supported by local node.	1, RW
7	<b>TX</b>	1 = 100Base-TX is supported by local node; 0 = 100Base-TX not supported by local node.	1, RW
6	<b>10FD</b>	1 = 10Base-T full duplex supported by local node; 0 = 10Base-T full duplex not supported by local node.	1, RW
5	<b>10</b>	1 = 10Base-T is supported by local node; 0 = 10Base-T not supported by local node.	1, RW
4-0	<b>Selector</b>	Binary encoded selector supported by this node. Currently only CSMA/CD <00001> is specified. No other protocols are supported.	<00001>, RW

## 5.21 Auto-Negotiation Link Partner Ability Register (Offset 0068h-0069h, R)

This register contains the advertised abilities of the Link Partner as received during Auto-negotiation. The content changes after the successful Auto-negotiation if Next-pages are supported.

Bit	Name	Description/Usage	Default/Attribute
15	<b>NP</b>	Next Page bit. 1 = transmitting the protocol specific data page; 0 = transmitting the primary capability data page	0, RO
14	<b>ACK</b>	1 = link partner acknowledges reception of local node's capability data word.	0, RO
13	<b>RF</b>	1 = link partner is indicating a remote fault.	0, RO
12-11	-	Reserved	-
10	<b>Pause</b>	1 = Flow control is supported by link partner , 0 = Flow control is not supported by link partner.	0, RO
9	<b>T4</b>	1 = 100Base-T4 is supported by link partner; 0 = 100Base-T4 not supported by link partner.	0, RO
8	<b>TXFD</b>	1 = 100Base-TX full duplex is supported by link partner; 0 = 100Base-TX full duplex not supported by link partner.	0, RO
7	<b>TX</b>	1 = 100Base-TX is supported by link partner; 0 = 100Base-TX not supported by link partner.	0, RO
6	<b>10FD</b>	1 = 10Base-T full duplex is supported by link partner; 0 = 10Base-T full duplex not supported by link partner.	0, RO
5	<b>10</b>	1 = 10Base-T is supported by link partner; 0 = 10Base-T not supported by link partner.	0, RO
4-0	<b>Selector</b>	Link Partner's binary encoded node selector. Currently only CSMA/CD <00001> is specified.	<00000>, RO

## 5.22 Auto-Negotiation Expansion Register (Offset 006Ah-006Bh, R)

This register contains additional status for NWay auto-negotiation.

Bit	Name	Description/Usage	Default/Attribute
15-5	-	Reserved. These bits are always set to 0.	-
4	<b>MLF</b>	Status indicating if a multiple link fault has occurred. 1 = fault occurred; 0 = no fault occurred.	0, RO
3	<b>LP_NP_ABLE</b>	Status indicating if the link partner supports Next Page negotiation. 1 = supported; 0 = not supported.	0, RO
2	<b>NP_ABLE</b>	This bit indicates if the local node is able to send additional Next Pages.	0, RO
1	<b>PAGE_RX</b>	This bit is set when a new Link Code Word Page has been received. The bit is automatically cleared when the auto-negotiation link partner's ability register (register 5) is read by management.	0, RO
0	<b>LP_NW_ABLE</b>	1 = link partner supports NWay auto-negotiation.	0, RO

## 5.23 Disconnect Counter (Offset 006Ch-006Dh, R)

Bit	Name	Description/Usage	Default/Attribute
15-0	DCNT	This 16-bit counter increments by 1 for every disconnect event. It rolls over when becomes full. It is cleared to zero by read command.	h'[0000], R

## 5.24 False Carrier Sense Counter (Offset 006Eh-006Fh, R)

This counter provides information required to implement the “FalseCarriers” attribute within the MAU managed object class of Clause 30 of IEEE 802.3u specification.

Bit	Name	Description/Usage	Default/Attribute
15-0	FCSCNT	This 16-bit counter increments by 1 for each false carrier event. It is cleared to zero by read command.	h'[0000], R

## 5.25 NWay Test Register (Offset 0070h-0071h, R/W)

Bit	Name	Description/Usage	Default/Attribute
15-8	-	Reserved	-
7	NWLPBK	1 = set NWay to loopback mode.	0, RW
6-4	-	Reserved	-
3	ENNWLE	1 = LED0 Pin indicates linkpulse	0, RW
2	FLAGABD	1 = Auto-neg experienced ability detect state	0, RO
1	FLAGPDF	1 = Auto-neg experienced parallel detection fault state	0, RO
0	FLAGLSC	1 = Auto-neg experienced link status check state	0, RO

## 5.26 RX\_ER Counter (Offset 0072h-0073h, R)

Bit	Name	Description/Usage	Default/Attribute
15-0	RXERCNT	This 16-bit counter increments by 1 for each valid packet received. It is cleared to zero by a read command.	h'[0000], R

## 5.27 CS Configuration Register (Offset 0074h-0075h, R/W)

Bit	Name	Description/Usage	Default/Attribute
15	<b>Testfun</b>	1 = Auto-neg speeds up internal timer	0, WO
14-10	-	Reserved	-
9	<b>LD</b>	Active low TPI link disable signal. When low, TPI still transmits link pulses and TPI stays in good link state.	1, RW
8	<b>HEART BEAT</b>	1 = HEART BEAT enable, 0 = HEART BEAT disable. HEART BEAT function is only valid in 10Mbps mode.	1, RW
7	<b>JBEN</b>	1 = enable jabber function. 0 = disable jabber function	1, RW
6	<b>F_LINK_100</b>	Used to login force good link in 100Mbps for diagnostic purposes. 1 = DISABLE, 0 = ENABLE.	1, RW
5	<b>F_Connect</b>	Assertion of this bit forces the disconnect function to be bypassed.	0, RW
4	-	Reserved	-
3	<b>Con_status</b>	This bit indicates the status of the connection. 1 = valid connected link detected; 0 = disconnected link detected.	0, RO
2	<b>Con_status_En</b>	Assertion of this bit configures LED1 pin to indicate connection status.	0, RW
1	-	Reserved	-
0	<b>PASS_SCR</b>	Bypass Scramble	0, RW

## 5.28 Config5: Configuration Register 5 (Offset 00D8h, R/W)

This register, unlike other Config registers, is not protected by 93C46 Command register. I.e. there is no need to enable Config register write prior to writing to Config5.

Bit	R/W	Symbol	Description
7	-	-	<b>Reserved</b>
6	R/W	BWF	<b>Broadcast Wakeup Frame:</b> 1: Enable Broadcast Wakeup Frame with mask bytes of only DID field = FF FF FF FF FF FF. 0: Default value. Disable Broadcast Wakeup Frame with mask bytes of only DID field = FF FF FF FF FF FF. The power-on default value of this bit is 0.
5	R/W	MWF	<b>Multicast Wakeup Frame:</b> 1: Enable Multicast Wakeup Frame with mask bytes of only DID field, which is a multicast address. 0: Default value. Disable Multicast Wakeup Frame with mask bytes of only DID field, which is a multicast address. The power-on default value of this bit is 0.
4	R/W	UWF	<b>Unicast Wakeup Frame:</b> 1: Enable Unicast Wakeup Frame with mask bytes of only DID field, which is its own physical address. 0: Default value. Disable Unicast Wakeup Frame with mask bytes of only DID field, which is its own physical address. The power-on default value of this bit is 0.
3	R/W	FIFOAddrPtr	<b>FIFO Address Pointer:</b> (Realtek internal use only to test FIFO SRAM) 1: Both Rx and Tx FIFO address pointers are updated in descending way from 1FFh and downwards. The initial FIFO address pointer is 1FFh. 0: (Power-on) default value. Both Rx and Tx FIFO address pointers are updated in ascending way from 0 and upwards. The initial FIFO address pointer is 0. Note: This bit does not participate in EEPROM auto-load. The FIFO address pointers can not be reset, except initial power-on. The power-on default value of this bit is 0.
2	R/W	LDPS	<b>Link Down Power Saving mode:</b> 1: Disable. 0: Enable. When cable is disconnected(Link Down), the analog part will power down itself (PHY Tx part & part of twister) automatically except PHY Rx part and part of twister to monitor SD signal in case that cable is re-connected and Link should be established again.
1	R/W	LANWake	<b>LANWake signal enable/disable:</b> 1: Enable LANWake signal. 0: Disable LANWake signal.
0	R/W	PME_STS	<b>PME_Status bit:</b> Always sticky/can be reset by PCI RST# and software. 1: The PME_Status bit can be reset by PCI reset or by software. 0: The PME_Status bit can only be reset by software.

- Config5 register, offset D8h: (SYM\_ERR register is changed to Config5, the function of SYM\_ERR register is no longer supported by RTL8100B(L).)
- The 3 bits (bit2-0) are auto-loaded from EEPROM Config5 byte to RTL8100B(L) Config5 register.

## 6. EEPROM (93C46) Contents

The 93C46 is a 1K-bit EEPROM. Although it is actually addressed by words, its contents are listed below by bytes for convenience. The RTL8100B(L) performs a series of EEPROM read operations from the 93C46 addresses 00H to 31H.

\* It is suggested to obtain Realtek approval before changing the default settings of the EEPROM.

Bytes	Contents	Description
00h 01h	29h 81h	These 2 bytes contain the ID code word for the RTL8100B(L). The RTL8100B(L) will load the contents of the EEPROM into the corresponding location if the ID word (8129h) is right, otherwise, the RTL8100B(L) will not proceed with the EEPROM autoloading process.
02h-05h	-	Reserved. The RTL8100B(L) no longer supports autoloading of Vendor ID and Device ID. The default values of VID and DID are hex 10EC and 8139, respectively.
06h-07h	SVID	PCI Subsystem Vendor ID, PCI configuration space offset 2Ch-2Dh.
08h-09h	SMID	PCI Subsystem ID, PCI configuration space offset 2Eh-2Fh.
0Ah	MNGNT	PCI Minimum Grant Timer, PCI configuration space offset 3Eh.
0Bh	MXLAT	PCI Maximum Latency Timer, PCI configuration space offset 3Fh.
0Ch	MSRBMCR	Bits 7-6 map to bits 7-6 of the Media Status register (MSR); Bits 5, 4, 0 map to bits 13, 12, 8 of the Basic Mode Control register (BMCR); Bits 3-2 are reserved. If the network speed is set to Auto-Detect mode (i.e. Nway mode), then Bit 1=0 means the local RTL8100B(L) supports flow control (IEEE 802.3x). In this case, Bit 10=1 in the Auto-negotiation Advertisement Register (offset 66h-67h), and Bit 1=1 means the local RTL8100B(L) does not support flow control. In this case, Bit 10=0 in Auto-negotiation Advertisement. This is because there are Nway switch hubs which keep sending flow control pause packets for no reason, if the link partner supports Nway flow control.
0Dh	CONFIG3	RTL8100B(L) Configuration register 3, operational register offset 59h.
0Eh-13h	Ethernet ID	After auto-load command or hardware reset, the RTL8100B(L) loads the Ethernet ID to IDR0-IDR5 of RTL8100B(L)'s I/O registers.
14h	CONFIG0	RTL8100B(L) Configuration register 0, operational registers offset 51h.
15h	CONFIG1	RTL8100B(L) Configuration register 1, operational registers offset 52h.
16h-17h	PMC	Reserved. Do not change this field without Realtek approval. Power Management Capabilities. PCI configuration space address 52h and 53h.
18h	PMCSR	Reserved. Do not change this field without Realtek approval. Power Management Control/Status. PCI configuration space address 55h.
19h	CONFIG4	Reserved. Do not change this field without Realtek approval. RTL8100B(L) Configuration register 4, operational registers offset 5Ah.
1Ah-1Dh	PHY1_PARM_U	Reserved. Do not change this field without Realtek approval. PHY Parameter 1-U for RTL8100B(L). Operational registers of the RTL8100B(L) are from 78h to 7Bh.
1Eh	PHY2_PARM_U	Reserved. Do not change this field without Realtek approval. PHY Parameter 2-U for RTL8100B(L). Operational register of the RTL8100B(L) is 80h.



1Fh	CONFIG_5	<p>Do not change this field without Realtek approval.</p> <p>Bit7-3: Reserved.</p> <p>Bit2: Link Down Power Saving mode: Set to 1: Disable. Set to 0: Enable. When cable is disconnected(Link Down), the analog part will power down itself (PHY Tx part &amp; part of twister) automatically except PHY Rx part and part of twister to monitor SD signal in case that cable is re-connected and Link should be established again.</p> <p>Bit1: LANWake signal Enable/Disable Set to 1: Enable LANWake signal. Set to 0: Disable LANWake signal.</p> <p>Bit0: PME_Status bit property Set to 1: The PME_Status bit can be reset by PCI reset or by software if D3cold_support_PME is 0. If D3cold_support_PME=1, the PME_Status bit is a sticky bit. Set to 0: The PME_Status bit is always a sticky bit and can only be reset by software.</p>
20h-23h	TW_PARM_U	Reserved. Do not change this field without Realtek approval. Twister Parameter U for RTL8100B(L). Operational registers of the RTL8100B(L) are 7Ch-7Fh.
24h-27h	TW_PARM_T	Reserved. Do not change this field without Realtek approval. Twister Parameter T for RTL8100B(L). Operational registers of the RTL8100B(L) are 7Ch-7Fh.
28h-2Bh	PHY1_PARM_T	Reserved. Do not change this field without Realtek approval. PHY Parameter 1-T for RTL8100B(L). Operational registers of the RTL8100B(L) are from 78h to 7Bh.
2Ch	PHY2_PARM_T	Reserved. Do not change this field without Realtek approval. PHY Parameter 2-T for RTL8100B(L). Operational register of the RTL8100B(L) is 80h.
2Dh-31h	-	Reserved.
32h-33h	Checksum	Reserved. Do not change this field without Realtek approval. Checksum of the EEPROM content.
34h-3Eh	-	Reserved. Do not change this field without Realtek approval.
3Fh	PXE_Para	Reserved. Do not change this field without Realtek approval. PXE ROM code parameter.
40h-7Fh	VPD_Data	VPD data field. Offset 40h is the start address of the VPD data.

## 6.1 Summary of the RTL8100B(L) EEPROM Registers

Offset	Name	Type	Bit7	Bit6	Bit5	Bit4	Bit3	Bit2	Bit1	Bit0
00h-05h	IDR0 – IDR5	R/W*								
51h	CONFIG0	R		-	-	-	-	BS2	BS1	BS0
		W*	-	-	-	-	-	-	-	-
52h	CONFIG1	R	LEDS1	LEDS0	DVRLOAD	LWACT	MEMMAP	IOMAP	VPD	PMEN
		W*	LEDS1	LEDS0	DVRLOAD	LWACT	-	-	VPD	PMEN
58h	MSRBMCR	R	TxFCE	RxFCE	-	-	-	-		
		W*	TxFCE	RxFCE	-	-	-	-		
63H	MSRBMCR	R	-	-	Spd Set	ANE	-	-	-	FUDUP
		W*	-	-	Spd Set	ANE	-	-	-	FUDUP
59h	CONFIG3	R	GNTDel	PARM_EN	Magic	LinkUp	-	-	-	FBtBEn
		W*	-	PARM_EN	Magic	LinkUp	-	-	-	-
5Ah	CONFIG4	R/W*	RxFIFOAutoClr	AnaOff	LongWF	LWPME	-	LWPTN	-	-
78h-7Bh	PHY1_PARM	R/W**	32 bit Read Write							
7Ch-7Fh	TW1_PARM	R/W**	32 bit Read Write							
	TW2_PARM		32 bit Read Write							
80h	PHY2_PARM	R/W**	8 bit Read Write							
D8h	CONFIG5	R/W*	-	-	-	-	-	LDPS	LANWake	PME STS

\* The registers marked with type = 'W\*' can be written only if bits EEM1=EEM0=1.

\*\* The registers marked with type = 'W\*\*', can be written only if bits EEM1=EEM0=1 and CONFIG3<PARM\_EN> = 0.

## 6.2 Summary of EEPROM Power Management Registers

Configuration Space offset	Name	Type	Bit7	Bit6	Bit5	Bit4	Bit3	Bit2	Bit1	Bit0
52h	PMC	R	Aux_I b1	Aux_I b0	DSI	Reserved	PMECLK	Version		
53h		R	PME_D3 <sub>cold</sub>	PME_D3 <sub>hot</sub>	PME_D2	PME_D1	PME_D0	D2	D1	Aux_I b2
55h	PMCSR	R	PME_Status	-	-	-	-	-	-	PME En
		W	PME_Status	-	-	-	-	-	-	PME En

## 7. PCI Configuration Space Registers

### 7.1 PCI Configuration Space Table

No.	Name	Type	Bit7	Bit6	Bit5	Bit4	Bit3	Bit2	Bit1	Bit0
00h	VID	R	1	1	1	0	1	1	0	0
01h		R	0	0	0	1	0	0	0	0
02h	DID	R	0	0	1	1	1	0	0	1
03h		R	1	0	0	0	0	0	0	1
04h	Command	R	0	PERRSP	0	0	-	BMEN	MEMEN	IOEN
		W	-	PERRSP	-	-	-	BMEN	MEMEN	IOEN
05h		R	0	0	0	0	0	0	FBTBEN	SERREN
		W	-	-	-	-	-	-	-	SERREN
06h	Status	R	FBBC	0	0	NewCap	0	0	0	0
07h		R	DPERR	SSERR	RMABT	RTABT	STABT	DST1	DST0	DPD
	W	DPERR	SSERR	RMABT	RTABT	STABT	-	-	DPD	
08h	Revision ID	R	0	0	0	0	0	0	0	0
09h	PIFR	R	0	0	0	0	0	0	0	0
0Ah	SCR	R	0	0	0	0	0	0	0	0
0Bh	BCR	R	0	0	0	0	0	0	1	0
0Ch	CLS	R	0	0	0	0	0	0	0	0
0Dh	LTR	R	LTR7	LTR6	LTR5	LTR4	LTR3	LTP2	LTR1	LTR0
		W	LTR7	LTR6	LTR5	LTR4	LTR3	LTP2	LTR1	LTR0
0Eh	HTR	R	0	0	0	0	0	0	0	0
0Fh	BIST	R	0	0	0	0	0	0	0	0
10h	IOAR	R	0	0	0	0	0	0	0	IOIN
		W	-	-	-	-	-	-	-	-
11h		R/W	IOAR15	IOAR14	IOAR13	IOAR12	IOAR11	IOAR10	IOAR9	IOAR8
12h		R/W	IOAR23	IOAR22	IOAR21	IOAR20	IOAR19	IOAR18	IOAR17	IOAR16
13h		R/W	IOAR31	IOAR30	IOAR29	IOAR28	IOAR27	IOAR26	IOAR25	IOAR24
14h	MEMAR	R	0	0	0	0	0	0	0	MEMIN
		W	-	-	-	-	-	-	-	-
15h		R/W	MEM15	MEM14	MEM13	MEM12	MEM11	MEM10	MEM9	MEM8
16h		R/W	MEM23	MEM22	MEM21	MEM20	MEM19	MEM18	MEM17	MEM16
17h		R/W	MEM31	MEM30	MEM29	MEM28	MEM27	MEM26	MEM25	MEM24
18h-2Bh	RESERVED									
2Ch	SVID	R	SVID7	SVID6	SVID5	SVID4	SVID3	SVID2	SVID1	SVID0
2Dh		R	SVID15	SVID14	SVID13	SVID12	SVID11	SVID10	SVID9	SVID8
2Eh	SMID	R	SMID7	SMID6	SMID5	SMID4	SMID3	SMID2	SMID1	SMID0
2Fh		R	SMID15	SMID14	SMID13	SMID12	SMID11	SMID10	SMID9	SMID8
30h-33h	Reserved	-	-	-	-	-	-	-	-	-
34h	Cap_Ptr	R	0	1	0	1	0	0	0	0
35h-3Bh	RESERVED									
3Ch	ILR	R/W	ILR7	ILR6	ILR5	ILR4	ILR3	ILR2	ILR1	ILR0
3Dh	IPR	R	0	0	0	0	0	0	0	1
3Eh	MNGNT	R	0	0	1	0	0	0	0	0
3Fh	MXLAT	R	0	0	1	0	0	0	0	0
40h-4Fh	RESERVED									
50h	PMID	R	0	0	0	0	0	0	0	1
51h	NextPtr	R	0	0	0	0	0	0	0	0
52h	PMC	R	Aux_I b1	Aux_I b0	DSI	Reserved	PMECLK	Version		

53h		R	PME_D3 <sub>cold</sub>	PME_D3 <sub>hot</sub>	PME_D2	PME_D1	PME_D0	D2	D1	Aux_I_b2
54h	PMCSR	R	0	0	0	0	0	0	Power State	
		W	-	-	-	-	-	-	Power State	
55h		R	PME_Status	-	-	-	-	-	-	PME_En
		W	PME_Status	-	-	-	-	-	-	PME_En
56h-5Fh	RESERVED									
60h	VPDID	R	0	0	0	0	0	0	1	1
61h	NextPtr	R	0	0	0	0	0	0	0	0
62h	Flag VPD Address	R/W	VPDADDR 7	VPDADDR 6	VPDADD R5	VPDADD R4	VPDADD R3	VPDADD R2	VPDADD R1	VPDADD R0
63h		R/W	Flag	VPDADDR 14	VPDADD R13	VPDADD R12	VPDADD R11	VPDADD R10	VPDADD R9	VPDADD R8
64h	VPD Data	R/W	Data7	Data6	Data5	Data4	Data3	Data2	Data1	Data0
65h		R/W	Data15	Data14	Data13	Data12	Data11	Data10	Data9	Data8
66h		R/W	Data23	Data22	Data21	Data20	Data19	Data18	Data17	Data16
67h		R/W	Data31	Data30	Data29	Data28	Data27	Data26	Data25	Data24
68h-FFh	RESERVED									

## 7.2 PCI Configuration Space Functions

The PCI configuration space is intended for configuration, initialization, and catastrophic error handling functions. The functions of RTL8100B(L)'s configuration space are described below.

**VID:** Vendor ID. This field will default to a value of 10ECh which is Realtek Semiconductor's PCI Vendor ID.

**DID:** Device ID. This field will default to a value of 8139h.

**Command:** The command register is a 16-bit register used to provide coarse control over a device's ability to generate and respond to PCI cycles.

Bit	Symbol	Description
15-10	-	<b>Reserved</b>
9	FBTBEN	<b>Fast Back-To-Back Enable:</b> Config3<FBTBEN>=0:Read as 0. Write operation has no effect. The RTL8100B(L) will not generate Fast Back-to-back cycles. When Config3<FbtBEn>=1, This read/write bit controls whether or not a master can do fast back-to-back transactions to different devices. Initialization software will set the bit if all targets are fast back-to-back capable. A value of 1 means the master is allowed to generate fast back-to-back transaction to different agents. A value of 0 means fast back-to-back transactions are only allowed to the same agent. This bit's state after RST# is 0.
8	SERREN	<b>System Error Enable:</b> When set to 1, the RTL8100B(L) asserts the SERRB pin when it detects a parity error on the address phase (AD<31:0> and CBEB<3:0> ).
7	ADSTEP	<b>Address/Data Stepping:</b> Read as 0, write operation has no effect. The RTL8100B(L) never performs address/data stepping.
6	PERRSP	<b>Parity Error Response:</b> When set to 1, RTL8100B(L) will assert the PERRB pin on the detection of a data parity error when acting as the target, and will sample the PERRB pin as the master. When set to 0, any detected parity error is ignored and the RTL8100B(L) continues normal operation. Parity checking is disabled after hardware reset (RSTB).
5	VGASNOOP	<b>VGA palette SNOOP:</b> Read as 0, write operation has no effect.
4	MWIEN	<b>Memory Write and Invalidate cycle Enable:</b> Read as 0, write operation has no effect.
3	SCYCEN	<b>Special Cycle Enable:</b> Read as 0, write operation has no effect. The RTL8100B(L) ignores all special cycle operation.
2	BMEN	<b>Bus Master Enable:</b> When set to 1, the RTL8100B(L) is capable of acting as a bus master. When set to 0, it is prohibited from acting as a PCI bus master. For the normal operation, this bit must be set by the system BIOS.
1	MEMEN	<b>Memory Space Access:</b> When set to 1, the RTL8100B(L) responds to memory space accesses. When set to 0, the RTL8100B(L) ignores memory space accesses.
0	IOEN	<b>I/O Space Access:</b> When set to 1, the RTL8100B(L) responds to IO space access. When set to 0, the RTL8100B(L) ignores I/O space accesses.

**Status:** The status register is a 16-bit register used to record status information for PCI bus related events. Reads to this register behave normally. Writes are slightly different in that bits can be reset, but not set.

Bit	Symbol	Description
15	DPERR	<b>Detected Parity Error:</b> When set indicates that the RTL8100B(L) detected a parity error, even if parity error handling is disabled in command register PERRSP bit.
14	SSERR	<b>Signaled System Error:</b> When set indicates that the RTL8100B(L) asserted the system error pin, SERRB. Writing a 1 clears this bit to 0.
13	RMABT	<b>Received Master Abort:</b> When set indicates that the RTL8100B(L) terminated a master transaction with master abort. Writing a 1 clears this bit to 0.
12	RTABT	<b>Received Target Abort:</b> When set indicates that the RTL8100B(L) master transaction was terminated due to a target abort. Writing a 1 clears this bit to 0.
11	STABT	<b>Signaled Target Abort:</b> Set to 1 whenever the RTL8100B(L) terminates a transaction with target abort. Writing a 1 clears this bit to 0.
10-9	DST1-0	<b>Device Select Timing:</b> These bits encode the timing of DEVSELB. They are set to 01b (medium), indicating the RTL8100B(L) will assert DEVSELB two clocks after FRAMEB is asserted.
8	DPD	<b>Data Parity error Detected:</b> This bit sets when the following conditions are met: <ul style="list-style-type: none"> <li>☼ The RTL8100B(L) asserts parity error(PERRB pin) or it senses the assertion of PERRB pin by another device.</li> <li>☼ The RTL8100B(L) operates as a bus master for the operation that caused the error.</li> <li>☼ The Command register PERRSP bit is set.</li> </ul> Writing a 1 clears this bit to 0.
7	FBBC	<b>Fast Back-To-Back Capable:</b> Config3<FbtBEN>=0, Read as 0, write operation has no effect. Config3<FbtBEN>=1, Read as 1.
6	UDF	<b>User Definable Features Supported:</b> Read as 0, write operation has no effect. The RTL8100B(L) does not support UDF.
5	66MHz	<b>66 MHz Capable:</b> Read as 0, write operation has no effect. The RTL8100B(L) has no 66MHz capability.
4	NewCap	<b>New Capability:</b> Config3<PMEn>=0, Read as 0, write operation has no effect. Config3<PMEn>=1, Read as 1.
0-3	-	<b>Reserved</b>

**RID:** Revision ID Register

The Revision ID register is an 8-bit register that specifies the RTL8100B(L) controller revision number.

**PIFR:** Programming Interface Register

The programming interface register is an 8-bit register that identifies the programming interface of the RTL8100B(L) controller. Because the PCI version 2.1 specification does not define any specific value for network devices, PIFR = 00h.

**SCR:** Sub-Class Register

The Sub-class register is an 8-bit register that identifies the function of the RTL8100B(L). SCR = 00h indicates that the RTL8100B(L) is an Ethernet controller.

**BCR:** Base-Class Register

The Base-class register is an 8-bit register that broadly classifies the function of the RTL8100B(L). BCR = 02h indicates that the RTL8100B(L) is a network controller.

**CLS:** Cache Line Size

Reads will return a 0, writes are ignored.

**LTR:** Latency Timer Register

Specifies, in units of PCI bus clocks, the value of the latency timer of the RTL8100B(L).

When the RTL8100B(L) asserts FRAMEB, it enables its latency timer to count. If the RTL8100B(L) deasserts FRAMEB prior to count expiration, the content of the latency timer is ignored. Otherwise, after the count expires, the RTL8100B(L) initiates transaction termination as soon as its GNTB is deasserted. Software is able to read or write, and the default value is 00H.

**HTR:** Header Type Register

Reads will return a 0, writes are ignored.

**BIST:** Built-in Self Test

Reads will return a 0, writes are ignored.

**IOAR:** This register specifies the BASE IO address which is required to build an address map during configuration. It also specifies the number of bytes required as well as an indication that it can be mapped into IO space.

Bit	Symbol	Description
31-8	IOAR31-8	<b>BASE IO Address:</b> This is set by software to the Base IO address for the operational register map.
7-2	IOSIZE	<b>Size Indication:</b> Read back as 0. This allows the PCI bridge to determine that the RTL8100B(L) requires 256 bytes of IO space.
1	-	<b>Reserved</b>
0	IOIN	<b>IO Space Indicator:</b> Read only. Set to 1 by the RTL8100B(L) to indicate that it is capable of being mapped into IO space.

**MEMAR:** This register specifies the base memory address for memory accesses to the RTL8100B(L) operational registers. This register must be initialized prior to accessing any of the RTL8100B(L)'s register with memory access.

Bit	Symbol	Description
31-8	MEM31-8	<b>Base Memory Address:</b> This is set by software to the base address for the operational register map.
7-4	MEMSIZE	<b>Memory Size:</b> These bits return 0, which indicates that the RTL8100B(L) requires 256 bytes of Memory Space.
3	MEMPF	<b>Memory Prefetchable:</b> Read only. Set to 0 by the RTL8100B(L).
2-1	MEMLOC	<b>Memory Location Select:</b> Read only. Set to 0 by the RTL8100B(L). This indicates that the base register is 32-bit wide and can be placed anywhere in the 32-bit memory space.
0	MEMIN	<b>Memory Space Indicator:</b> Read only. Set to 0 by the RTL8100B(L) to indicate that it is capable of being mapped into memory space.

**SVID:** Subsystem Vendor ID. This field will be set to a value corresponding to PCI Subsystem Vendor ID in the external EEPROM. If there is no EEPROM, this field will default to a value of 10ECh which is Realtek Semiconductor's PCI Subsystem Vendor ID.

**SMID:** Subsystem ID. This field will be set to value corresponding to PCI Subsystem ID in the external EEPROM. If there is no EEPROM, this field will default to a value of 8139h.

**BMAR:** This register is disabled in the RTL8100B(L).

**ILR:** Interrupt Line Register

The Interrupt Line Register is an 8-bit register used to communicate with the routing of the interrupt. It is written by the POST software to set interrupt line for the RTL8100B(L).

**IPR:** Interrupt Pin Register

The Interrupt Pin register is an 8-bit register indicating the interrupt pin used by the RTL8100B(L). The RTL8100B(L) uses INTA interrupt pin. Read only. IPR = 01H.

**MNGNT:** Minimum Grant Timer: Read only

Specifies how long a burst period the RTL8100B(L) needs at 33 MHz clock rate in units of 1/4 microsecond. This field will be set to a value from the external EEPROM. If there is no EEPROM, this field will default to a value of 20h.

**MXLAT:** Maximum Latency Timer: Read only

Specifies how often the RTL8100B(L) needs to gain access to the PCI bus in units of 1/4 microseconds. This field will be set to a value from the external EEPROM. If there is no EEPROM, this field will default to a value of 20h.

## 7.3 Default Values after Power-on (RSTB asserted)

PCI Configuration Space Table

No.	Name	Type	Bit7	Bit6	Bit5	Bit4	Bit3	Bit2	Bit1	Bit0
00h	VID	R	1	1	1	0	1	1	0	0
01h		R	0	0	0	1	0	0	0	0
02h	DID	R	0	0	1	1	1	0	0	1
03h		R	1	0	0	0	0	0	0	1
04h	Command	R	0	0	0	0	0	0	0	0
		W	-	PERRSP	-	-	-	-	BMEN	MEMEN
05h		R	0	0	0	0	0	0	0	0
		W	-	-	-	-	-	-	-	SERREN
06h	Status	R	0	0	0	NewCap	0	0	0	0
07h		R	0	0	0	0	0	0	1	0
		W	DPERR	SSERR	RMABT	RTABT	STABT	-	-	DPD
08h	Revision ID	R	0	0	0	0	0	0	0	0
09h	PIFR	R	0	0	0	0	0	0	0	0
0Ah	SCR	R	0	0	0	0	0	0	0	0
0Bh	BCR	R	0	0	0	0	0	0	1	0
0Ch	CLS	R	0	0	0	0	0	0	0	0
0Dh	LTR	R	0	0	0	0	0	0	0	0
		W	LTR7	LTR6	LTR5	LTR4	LTR3	LTP2	LTR1	LTR0
0Eh	HTR	R	0	0	0	0	0	0	0	0
0Fh	BIST	R	0	0	0	0	0	0	0	0
10h	IOAR	R	0	0	0	0	0	0	0	1
11h		R/W	0	0	0	0	0	0	0	0
12h		R/W	0	0	0	0	0	0	0	0
13h		R/W	0	0	0	0	0	0	0	0
14h	MEMAR	R	0	0	0	0	0	0	0	0
15h		R/W	0	0	0	0	0	0	0	0
16h		R/W	0	0	0	0	0	0	0	0
17h		R/W	0	0	0	0	0	0	0	0
18h-2Bh	RESERVED (ALL 0)									
2Ch	SVID	R	1	1	1	0	1	1	0	0
		R	0	0	0	1	0	0	0	1
2Eh	SMID	R	0	0	1	1	1	0	0	1
		R	1	0	0	0	0	0	0	1
30h-33h	Reserved	-	-	-	-	-	-	-	-	-
34h	Cap-Ptr	R	Ptr7	Ptr6	Ptr5	Ptr4	Ptr3	Ptr2	Ptr1	Ptr0
35h-3Bh	RESERVED (ALL 0)									
3Ch	ILR	R/W	0	0	0	0	0	0	0	0
3Dh	IPR	R	0	0	0	0	0	0	0	1
3Eh	MNGNT	R	0	0	1	0	0	0	0	0
3Fh	MXLAT	R	0	0	1	0	0	0	0	0
40h-FFh	-	RESERVED (ALL 0)								



## 7.4 PCI Power Management Functions

The RTL8100B(L) is compliant to ACPI (Rev 1.1), PCI Power Management (Rev 1.1), and Device Class Power Management Reference Specification (V1.0a), such as to support an OS Directed Power Management (OSPM) environment. To support this, the RTL8100B(L) provides the following capabilities:

- The RTL8100B(L) can monitor the network for a Wakeup Frame, a Magic Packet, or a Link Change, and notify the system via PME# when such a packet or event arrives. Then, the whole system can be restored to a working state to process the incoming jobs.
- The RTL8100B(L) can be isolated from the PCI bus automatically with the auxiliary power circuit when the PCI bus is in B3 state, i.e. the power on the PCI bus is removed. When the motherboard includes a built-in RTL8100B(L) single-chip fast Ethernet controller, the RTL8100B(L) can be disabled when needed by pulling the isolate pin low to 0V.

When the RTL8100B(L) is in power down mode (D1 ~ D3),

- ◆ The Rx state machine is stopped, and the RTL8100B(L) keeps monitoring the network for wakeup event such Magic Packet, Wakeup Frame, and/or Link Change, in order to wake up the system. When in power down mode, the RTL8100B(L) will not reflect the status of any incoming packets in the ISR register and will not receive any packets into the Rx FIFO.
- ◆ The FIFO status and the packets which are already contained in the Rx FIFO before entering power down mode are kept by the RTL8100B(L) during power down mode.
- ◆ The transmission is stopped. The action of PCI bus master mode is stopped as well. The Tx FIFO is kept.
- ◆ After restoration to D0 state, the PCI bus master mode continues to transfer the data, which is not yet moved into the Tx FIFO from the last break. The packet that was not transmitted completely last time is transmitted again.

D3cold\_support\_PME bit(bit15, PMC register) & Aux\_I\_b2:0 (bit8:6, PMC register) in PCI configuration space.

If 9346 D3cold\_support\_PME bit(bit15, PMC) = 1, the above 4 bits depend on the existence of Aux power.

If 9346 D3cold\_support\_PME bit(bit15, PMC) = 0, the above 4 bits are all 0's.

Ex.:

1. If 9346 D3c\_support\_PME = 1,
  - If Aux. power exists, then PMC in PCI config space is the same as 9346 PMC, i.e. if 9346 PMC = C2 F7, then PCI PMC = C2 F7.
  - Aux. power is absent, then PMC in PCI config space is the same as 9346 PMC except the above 4 bits are all 0's. I.e. if 9346 PMC = C2 F7, the PCI PMC = 02 76.
    - \* In this case, if wakeup support is desired when the main power is off, it is suggested that the EEPROM PMC be set to: C2 F7 (Realtek default value). It is not recommended to set the D0\_support\_PME bit to "1".
2. If 9346 D3c\_support\_PME = 0,
  - Aux. power exists, then PMC in PCI config space is the same as 9346 PMC. I.e. if 9346 PMC = C2 77, then PCI PMC = C2 77.
  - Aux. power is absent, then PMC in PCI config space is the same as 9346 PMC except the above 4 bits are all 0's. I.e. if 9346 PMC = C2 77, the PCI PMC = 02 76.
    - \* In this case, if wakeup support is not desired when the main power is off, it is suggested that the 9346 PMC to be 02 76. It is not recommended to set the D0\_support\_PME bit to "1".

Link Wakeup occurs only when the following conditions are met:

- ◆ The LinkUp bit (CONFIG3#4) is set to 1, the PMEn bit (CONFIG1#0) is set to 1, and the RTL8100B(L) is in isolation state, or the PME# can be asserted in current power state.
- ◆ The Link status is re-established.

Magic Packet Wakeup occurs only when the following conditions are met:

- ◆ The destination address of the received Magic Packet matches.
- ◆ The received Magic Packet does not contain a CRC error.

- ◆ The Magic bit (CONFIG3#5) is set to 1, the PMEn bit (CONFIG1#0) is set to 1, and the RTL8100B(L) is in isolation state, or the PME# can be asserted in current power state.
- ◆ The Magic Packet pattern matches, i.e. 6 \* FFh + MISC(can be none)+ 16 \* DID(Destination ID) in any part of a valid (Fast) Ethernet packet.

Wakeup Frame event occurs only when the following conditions are met:

- ◆ The destination address of the received Wakeup Frame matches.
- ◆ The received Wakeup Frame does not contain a CRC error.
- ◆ The PMEn bit (CONFIG1#0) is set to 1.
- ◆ The **8-bit CRC\*** (or **16-bit CRC**) of the received Wakeup Frame matches with the **8-bit CRC\*** (or **16-bit CRC**) of the sample Wakeup Frame pattern received from the local machine's OS.
- ◆ The **last masked byte\*\*** of the received Wakeup Frame matches with the **last masked byte\*\*** of the sample Wakeup Frame pattern provided by the local machine's OS. (In Long Wakeup Frame mode, the last masked byte field is replaced with the high byte of the 16-bit CRC.)

- **8-bit CRC:**

This 8-bit CRC logic is used to generate an 8-bit CRC from the masked bytes of the received Wakeup Frame packet within offset 12 to 75. Software should calculate the 8-bit Power Management CRC for each specific sample wakeup frame and store the calculated CRC in the corresponding CRC register for the RTL8100B(L) to check if there is a Wakeup Frame packet coming in.

- **16-bit CRC: (Long Wakeup Frame mode, the mask bytes cover from offset 0 to 127)**

*Long Wakeup Frame:* The RTL8100B(L) also supports 3 long Wakeup Frames. If the range of mask bytes of the sample Wakeup Frame, passed down by the OS to the driver, exceeds the range from offset 12 to 75, the related registers of wakeup frame 2 and 3 can be merged to support one long wakeup frame by setting the LongWF (bit0, CONFIG4). Thus, the range of effective mask bytes extends from offset 0 to 127. The low byte and high byte of the calculated 16-bit CRC should be put into register CRC2 and LSB\_CRC2 respectively. The mask bytes (16 bytes) should be stored to register Wakeup2 and Wakeup3. The CRC3 and LSB\_CRC3 have no meaning in this case and should be reset to 0. Long Wakeup Frame pairs are frames 4 and 5, and frames 6 and 7. The CRC5, CRC7, LSB\_CRC5, and LSB\_CRC7 have no meaning in this case and should be reset to 0, if the RTL8100B(L) is set to support long Wakeup Frames. In this case, the RTL8100B(L) support 5 wakeup frames, that are 2 normal wakeup frames and 3 long wakeup frames.

- \*\* **last masked byte:**

The last byte of the masked bytes of the received Wakeup Frame packet within offset 12 to 75 (in 8-bit CRC mode) should match the last byte of the masked bytes of the sample Wakeup Frame provided by the local machine's OS.

The PME# signal is asserted only when the following conditions are met:

- ◆ The PMEn bit (bit0, CONFIG1) is set to 1.
- ◆ The PME\_En bit (bit8, PMCSR) in PCI Configuration Space is set to 1.
- ◆ The RTL8100B(L) may assert PME# in current power state, or the RTL8100B(L) is in isolation state. Refer to PME\_Support(bit15-11) of the PMC register in PCI Configuration Space.
- ◆ Magic Packet, LinkUp, or Wakeup Frame has occurred.

\* Writing a 1 to the PME\_Status (bit15) of PMCSR register in the PCI Configuration Space will clear this bit and cause the RTL8100B(L) to stop asserting a PME# (if enabled).

When the RTL8100B(L) is in power down mode, ex. D1-D3, the IO, and MEM are all disabled. After RST# asserted, the power state must be changed to D0 if the original power state is D3<sub>cold</sub>. There is no hardware enforced delays at RTL8100B(L)'s power state. When in ACPI mode, the RTL8100B(L) does not support PME from D0 (owing to the setting of PMC register. This setting comes from EEPROM).

The RTL8100B(L) also supports the LAN WAKE-UP function. The LWAKE pin is used to notify the motherboard to execute the wake-up process whenever the RTL8100B(L) receives a wakeup event, such as Magic Packet.

The LWAKE signal is asserted according the following setting:

- ◆ LWPME bit (bit4, CONFIG4):
  - 0: The LWAKE is asserted whenever there is wakeup event occurs.
  - 1: The LWAKE can only be asserted when the PMEB is asserted and the ISOLATEB is low.
- ◆ Bit1 of DELAY byte(offset 1Fh, EEPROM):
  - 0: LWAKE signal is disabled.
  - 1: LWAKE signal is enabled

## 7.5 VPD (Vital Product Data)

Bit 31 of the VPD is used to issue VPD read/write commands and is also a flag used to indicate whether the transfer of data between the VPD data register and the 93C46 is completed or not.

1. Write VPD register: (write data to 93C46)  
Write the flag bit to a one at the same time the VPD address is written. When the flag bit is set to zero by the RTL8100B(L), the VPD data (all 4 bytes) has been transferred from the VPD data register to the 93C46.
2. Read VPD register: (read data from 93C46)  
Write the flag bit to a zero at the same time the VPD address is written. When the flag bit is set to one by the RTL8100B(L), the VPD data (all 4 bytes) has been transferred from 93C46 to the VPD data register.

## 8. Block Diagram

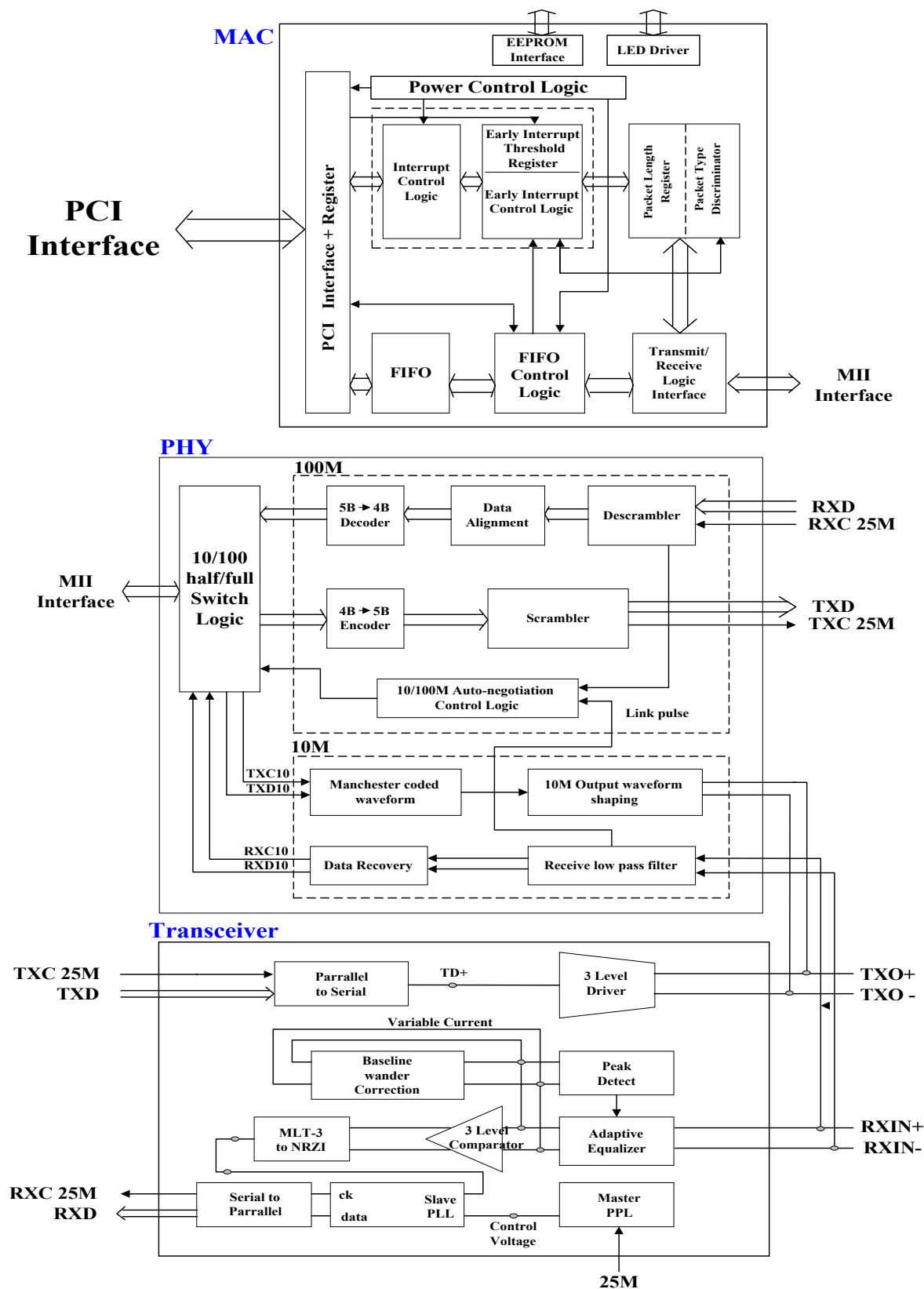

## 9. Functional Description

### 9.1 Transmit operation

The host CPU initiates a transmit by storing an entire packet of data in one of the descriptors in the main memory. When the entire packet has been transferred to the Tx buffer, the RTL8100B(L) is instructed to move the data from the Tx buffer to the internal transmit FIFO in PCI bus master mode. When the transmit FIFO contains a complete packet or is filled to the programmed threshold level, the RTL8100B(L) begins packet transmission.

### 9.2 Receive operation

The incoming packet is placed in the RTL8100B(L)'s Rx FIFO. Concurrently, the RTL8100B(L) performs address filtering of multicast packets according to its hash algorithms. When the amount of data in the Rx FIFO reaches the level defined in the Receive Configuration Register, the RTL8100B(L) requests the PCI bus to begin transferring the data to the Rx buffer in PCI bus master mode.

### 9.3 Wander Compensation

The 8100B(L) is ANSI TP-PMD compliant and supports input and Base Line Wander (BLW) compensation in 100Base-TX mode. The 8100B(L) does not require external attenuation circuitry at its receive inputs, RD+/- . It accepts TP-PMD compliant waveforms directly, requiring only a 100 $\Omega$  termination and a 1:1 transformer.

BLW is the change in the average DC content, over time, of an AC coupled digital transmission over a given transmission medium. BLW is a result from the interaction between the low frequency components of a transmitted bit stream and the frequency response of the AC coupling component(s) within the transmission system. If the low frequency content of the digital bit stream goes below the low frequency pole of the AC coupling transformers, then the droop characteristics of the transformers will dominate resulting in potentially serious BLW. If BLW is not compensated, packet loss can occur.

### 9.4 Signal Detect

The 8100B(L) supports signal detect in 100Base-TX mode. Therefore, the reception of normal 10Base-T link pulses and fast link pulses defined by IEEE 802.3u Auto-negotiation by the 100Base-TX receiver do not cause the 8100B(L) to assert signal detect.

The signal detect function of the 8100B(L) is incorporated to meet the specifications mandated by the ANSI FDDI TP-PMD standard as well as the IEEE 802.3 100Base-TX standard for both voltage thresholds and timing parameters.

### 9.5 Line Quality Monitor

The line quality monitor function is available in 100Base-TX mode. It is possible to determine the amount of Equalization being used by accessing certain test registers with the DSP engine. This provides a crude indication of connected cable length. This function allows for a quick and simple verification of the line quality in that any significant deviation from an expected register value (based on a known cable length) would indicate that the signal quality has deviated from the expected nominal case.

### 9.6 Clock Recovery Module

The Clock Recovery Module (CRM) is supported in 100Base-TX mode. The CRM accepts 125Mb/s MLT3 data from the equalizer. The DPLL locks onto the 125Mb/s data stream and extracts a 125MHz recovered clock. The extracted and synchronized clock and data are used as required by the synchronous receive operations.

### 9.7 Loopback Operation

Loopback mode is normally used to verify that the logic operations up to the Ethernet cable function correctly. In loopback mode for 100Mbps, the RTL8100B(L) takes frames from the transmit descriptor and transmits them up to internal Twister logic.

## 9.8 Tx Encapsulation

While operating in 100Base-TX mode, the RTL8100B(L) encapsulates the frames that it transmits according to the 4B/5B code-groups table. The changes of the original packet data are listed as follows :

1. The first byte of the preamble in the MAC frame is replaced with the JK symbol pair.
2. After the CRC, the TR symbol pair is inserted.

## 9.9 Collision

If the RTL8100B(L) is not in full-duplex mode, a collision event occurs when the receive input is not idle while the RTL8100B(L) transmits. If the collision was detected during the preamble transmission, the jam pattern is transmitted after completing the preamble (including the JK symbol pair).

## 9.10 Rx Decapsulation

The RTL8100B(L) continuously monitors the network when reception is enabled. When activity is recognized it starts to process the incoming data.

After detecting receive activity on the line, the RTL8100B(L) starts to process the preamble bytes based on the mode of operation.

While operating in 100Base-Tx mode, the RTL8100B(L) expects the frame to start with the symbol pair JK in the first byte of the 8-byte preamble.

The RTL8100B(L) checks the CRC bytes and checks if the packet data ends with the TR symbol pair, if not, the RTL8100B(L) reports an CRC error RSR.

The RTL8100B(L) reports a RSR<CRC> error in any of the following cases :

1. In the 100Base-Tx mode, one of the following occur.
  - a. An invalid symbol (4B/5B Table) is received in the middle of the frame.  
RSR<ISE> bit also sets.
  - b. The frame does not end with the TR symbol pair.

## 9.11 Flow Control

The RTL8100B(L) supports IEEE802.3X flow control to improve performance in full-duplex mode. It detects PAUSE packets to achieve flow control tasks.

### 9.11.1. Control Frame Transmission

When the RTL8100B(L) detects that its free receive buffer is less than 3K bytes, it sends a **PAUSE packet with pause\_time(=FFFFh)** to inform the source station to stop transmission for the specified period of time. After the driver has processed the packets in the receive buffer and updated the boundary pointer, the RTL8100B(L) sends the other **PAUSE packet with pause\_time(=0000h)** to wake up the source station to restart transmission.

### 9.11.2. Control Frame Reception

The RTL8100B(L) enters a back off state for a specified period of time when it receives a valid **PAUSE packet with pause\_time(=n)**. If the PAUSE packet is received while the RTL8100B(L) is transmitting, the RTL8100B(L) starts to back off after current transmission completes. The RTL8100B(L) is free to transmit the next packets when it receives a valid **PAUSE packet with pause\_time(=0000h)** or the **backoff timer(=n\*512 bit time)** elapses.

Note: The PAUSE operation cannot be used to inhibit transmission of MAC Control frames (e.g. PAUSE packet). The N-way flow control capability can be disabled, please refer to Section 6. EEPROM (93C46) Contents for a detailed description.

## 9.12 LED Functions

### 9.12.1 10/100 Mbps Link Monitor

The Link Monitor senses the link integrity or if a station is down.

### 9.12.2 LED\_RX

In 10/100 Mbps mode, the LED function is like the RTL8139C(L).

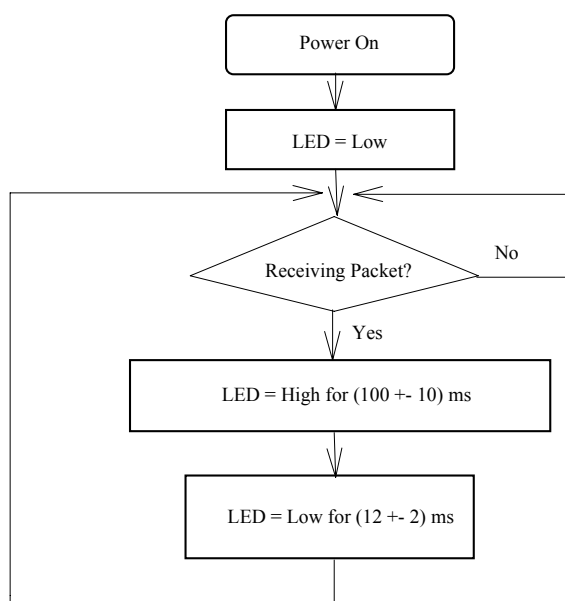

### 9.12.3 LED\_TX

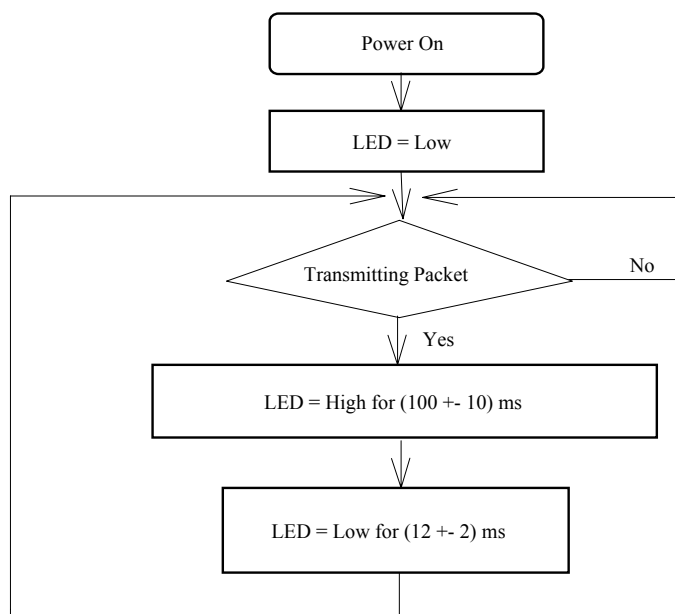

### 9.12.4 LED\_TX+LED\_RX

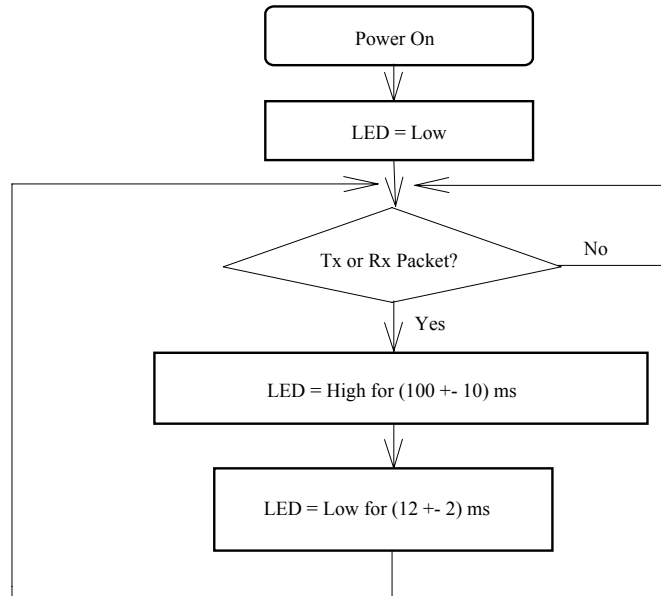

## 10. Application Diagram

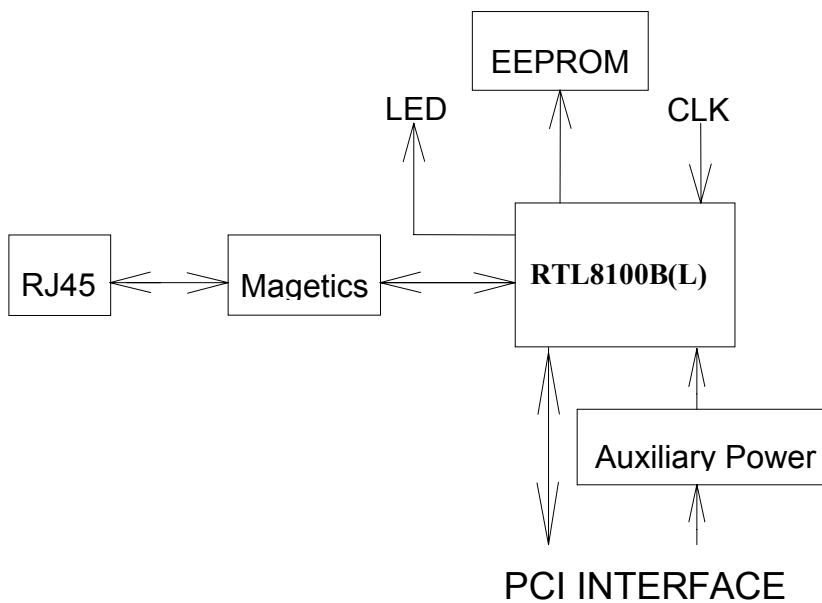



## 11. Electrical Characteristics

### 11.1 Temperature Limit Ratings

Parameter	Minimum	Maximum	Units
Storage temperature	-55	+125	°C
Operating temperature	0	70	°C

### 11.2 DC Characteristics

#### 11.2.1 Supply voltage

**Vcc = 3.0V min. to 3.6V max.**

Symbol	Parameter	Conditions	Minimum	Maximum	Units
V <sub>OH</sub>	Minimum High Level Output Voltage	I <sub>OH</sub> = -8mA	0.9 * Vcc	Vcc	V
V <sub>OL</sub>	Maximum Low Level Output Voltage	I <sub>OL</sub> = 8mA		0.1 * Vcc	V
V <sub>IH</sub>	Minimum High Level Input Voltage		0.5 * Vcc	Vcc+0.5	V
V <sub>IL</sub>	Maximum Low Level Input Voltage		-0.5	0.3 * Vcc	V
I <sub>IN</sub>	Input Current	V <sub>IN</sub> =V <sub>CC</sub> or GND	-1.0	1.0	uA
I <sub>OZ</sub>	Tri-State Output Leakage Current	V <sub>OUT</sub> =V <sub>CC</sub> or GND	-10	10	uA
I <sub>CC</sub>	Average Operating Supply Current	I <sub>OUT</sub> =0mA,		330	mA

#### 11.2.2 Supply voltage

**Vdd25 = 2.3V min. to 2.7V max.**

Symbol	Parameter	Conditions	Minimum	Maximum	Units
V <sub>OH</sub>	Minimum High Level Output Voltage	I <sub>OH</sub> = -8mA	0.9 * Vdd25	Vdd25	V
V <sub>OL</sub>	Maximum Low Level Output Voltage	I <sub>OL</sub> = 8mA		0.1 * Vdd25	V
V <sub>IH</sub>	Minimum High Level Input Voltage		0.5 * Vdd25	Vdd25+0.5	V
V <sub>IL</sub>	Maximum Low Level Input Voltage		-0.5	0.3 * Vdd25	V
I <sub>IN</sub>	Input Current	V <sub>IN</sub> =V <sub>dd25</sub> or GND	-1.0	1.0	uA
I <sub>OZ</sub>	Tri-State Output Leakage Current	V <sub>OUT</sub> =V <sub>dd25</sub> or GND	-10	10	uA
I <sub>dd25</sub>	Average Operating Supply Current	I <sub>OUT</sub> =0mA,		40	mA

## 11.3 AC Characteristics

### 11.3.1 PCI Bus Operation Timing

#### Target Read

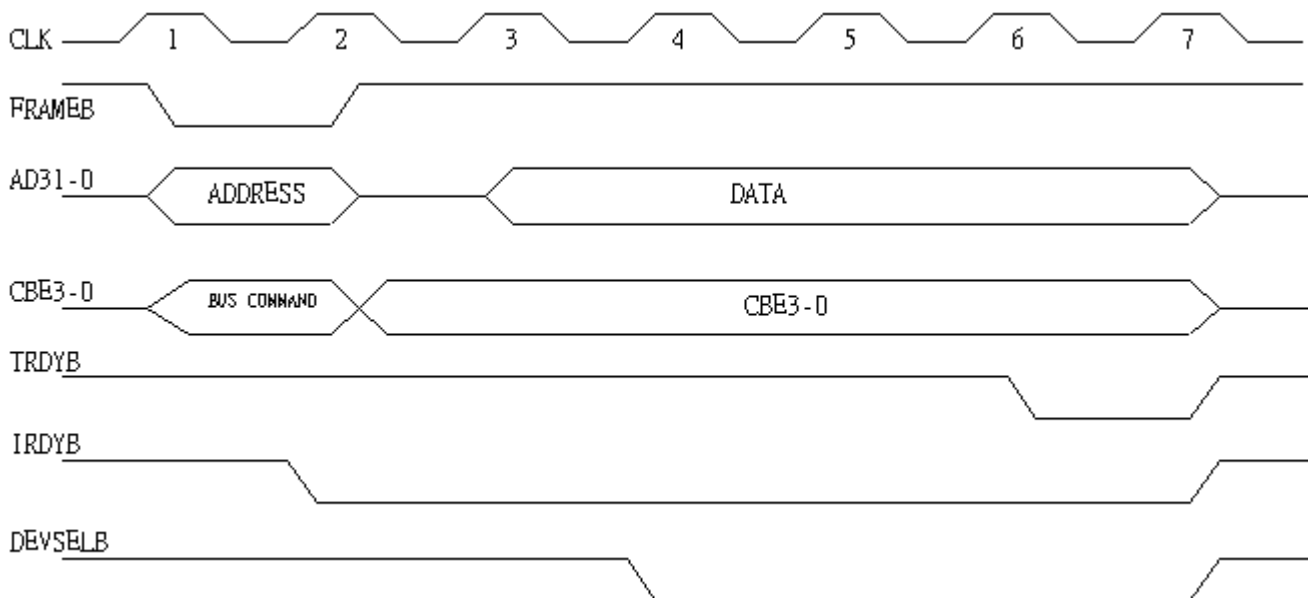

#### Target Write

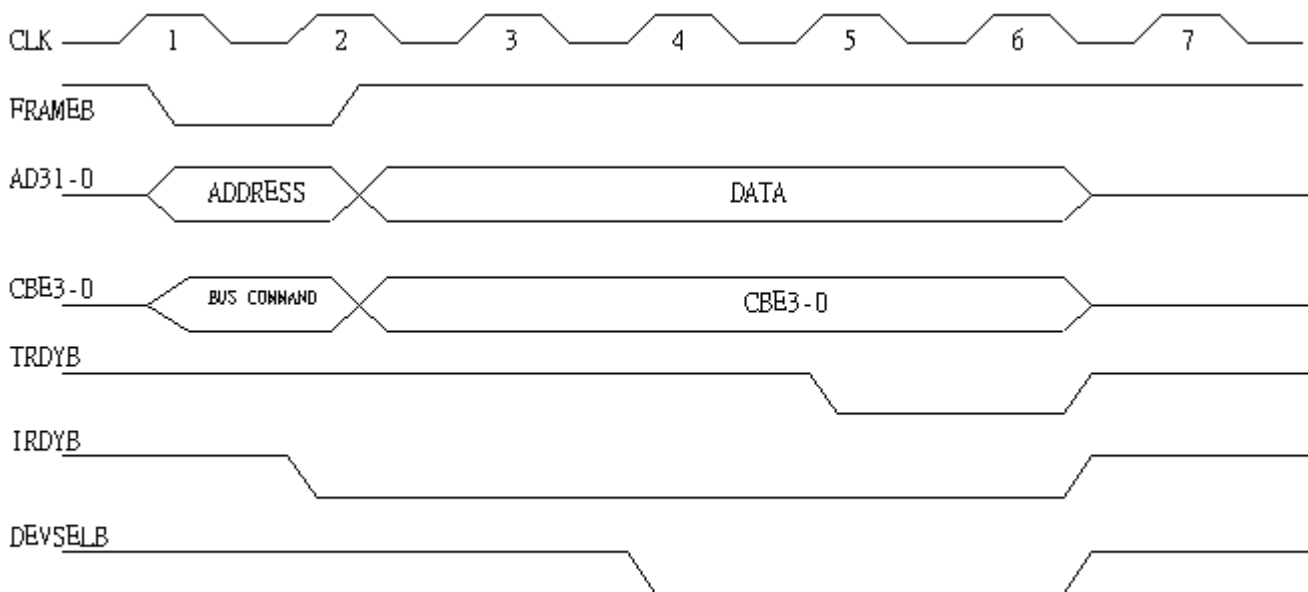

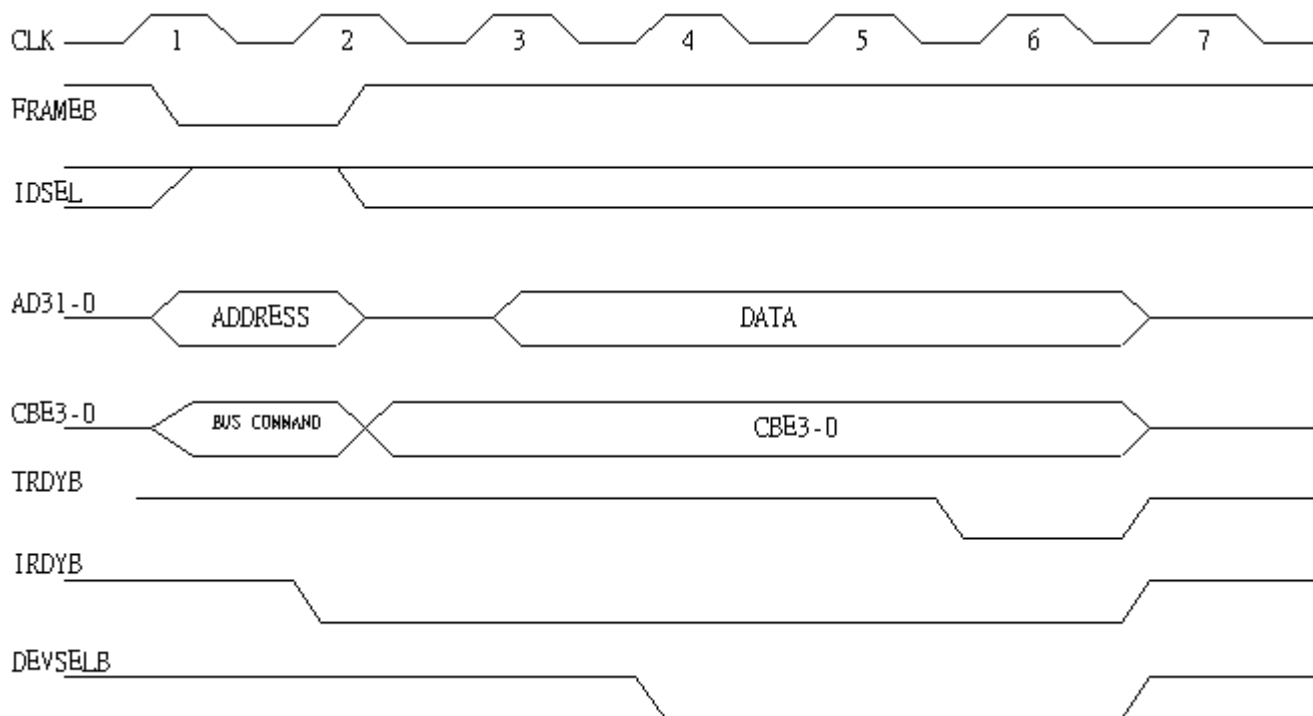
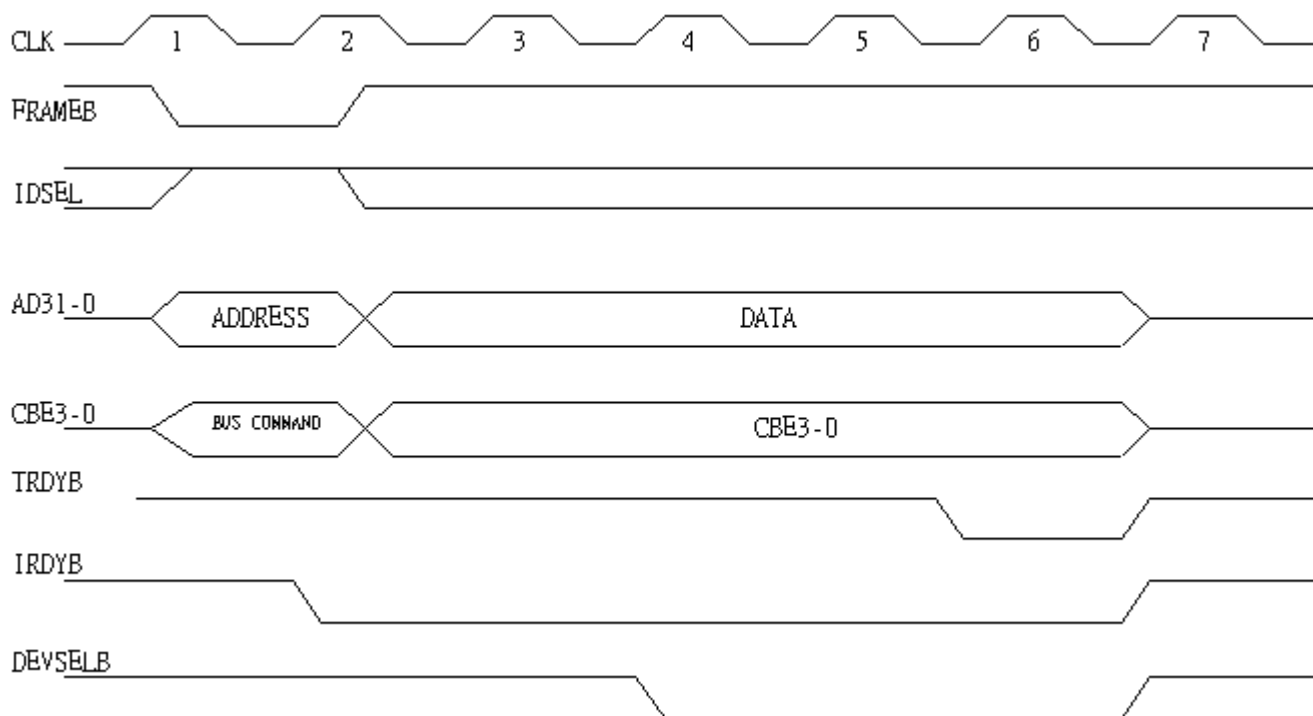
**Configuration Read**

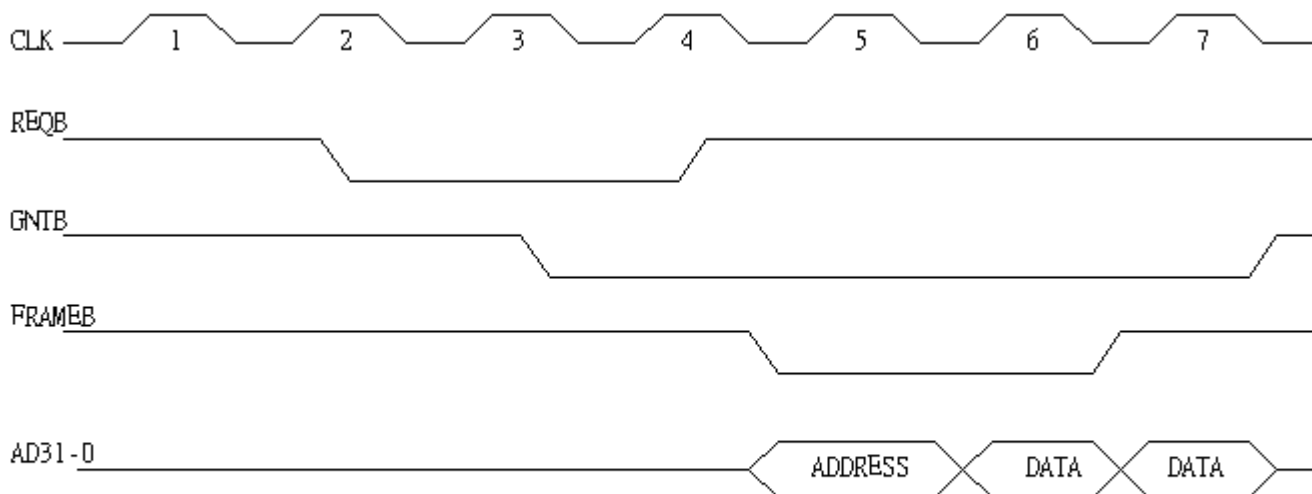
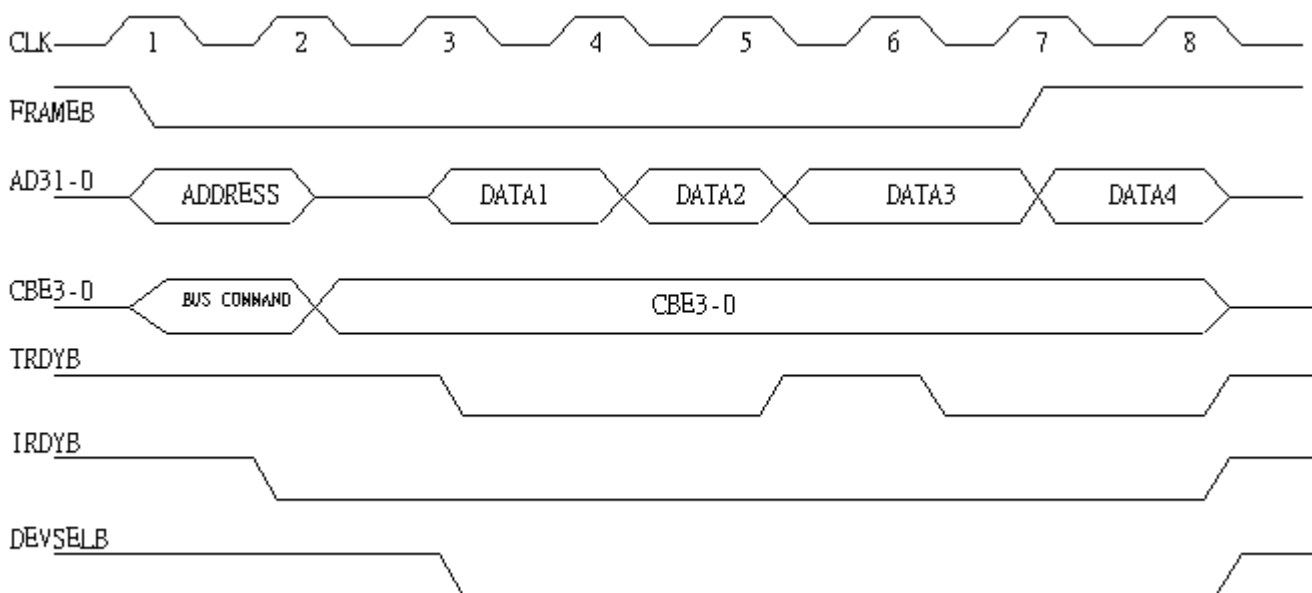
**Configuration Write**

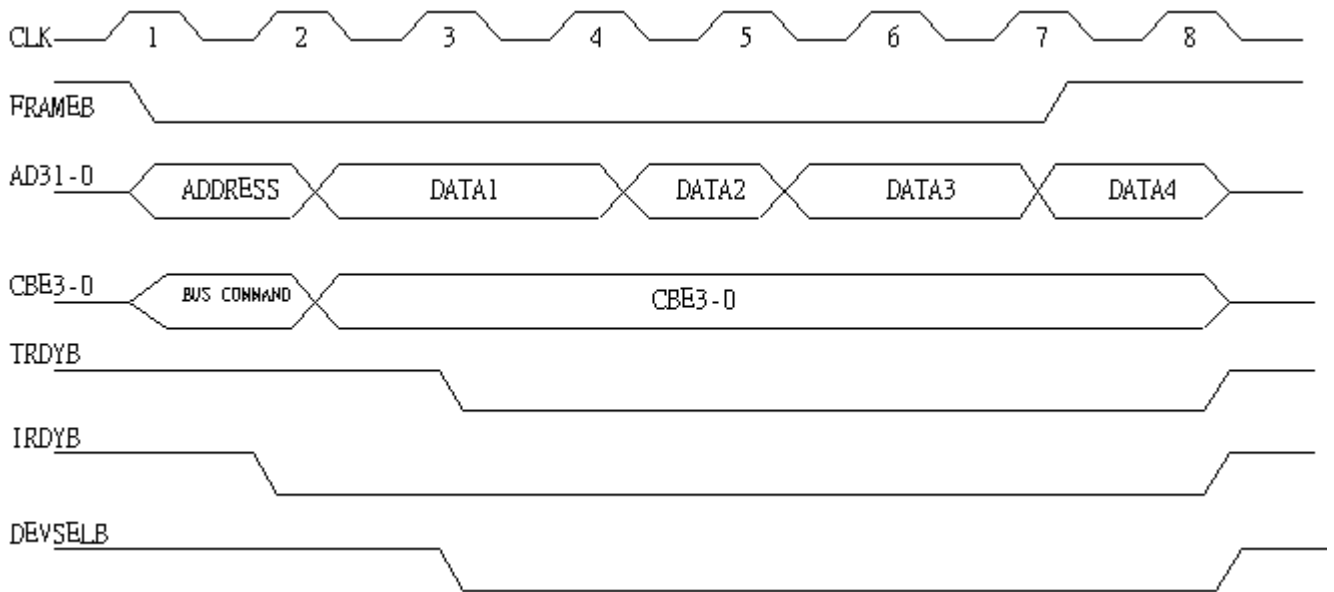
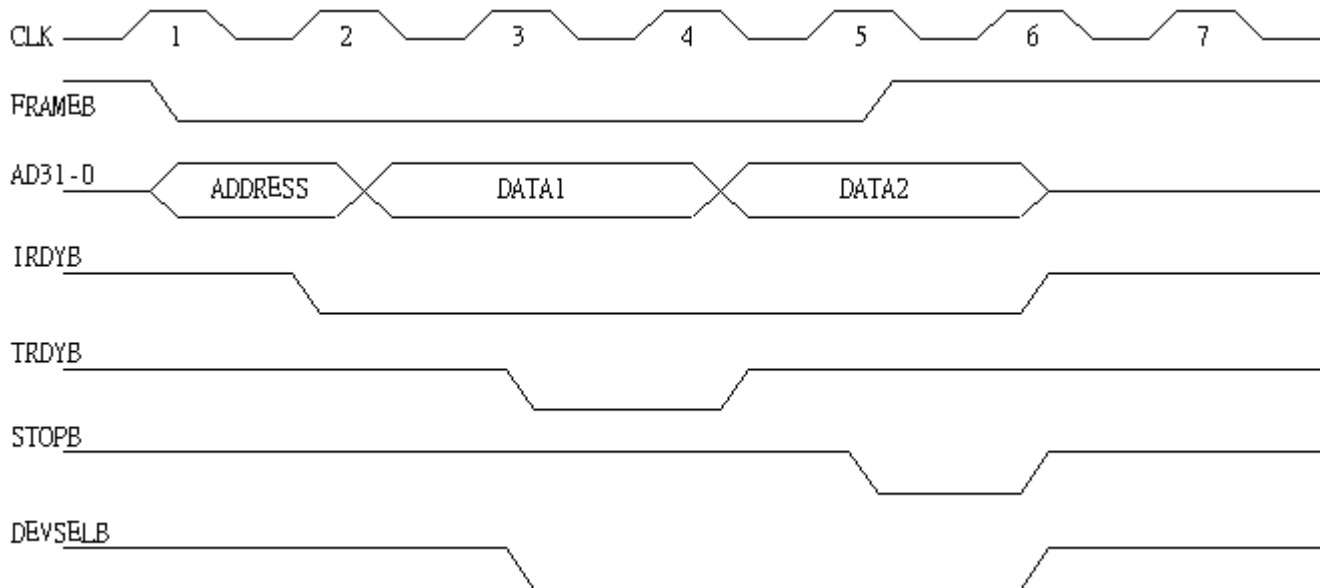
**BUS Arbitration**

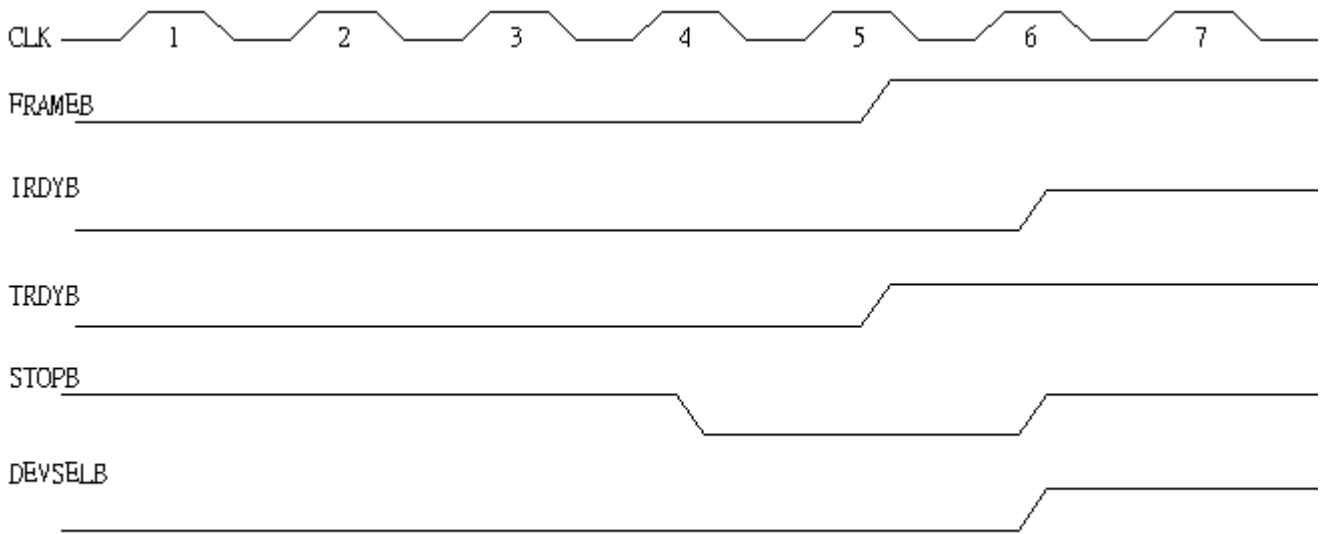
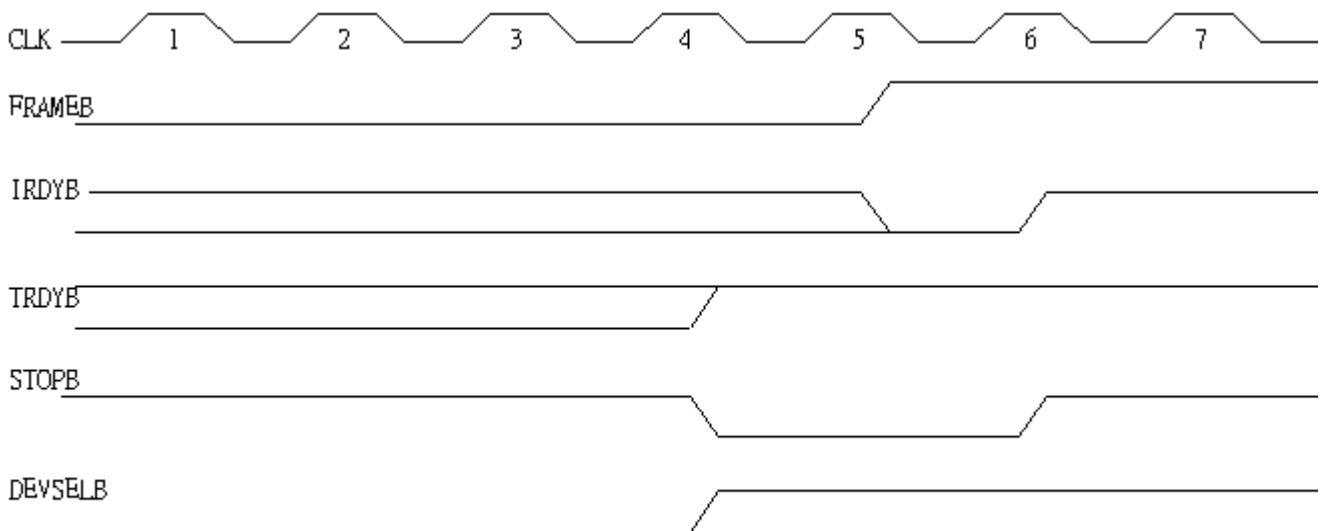
**Memory Read**

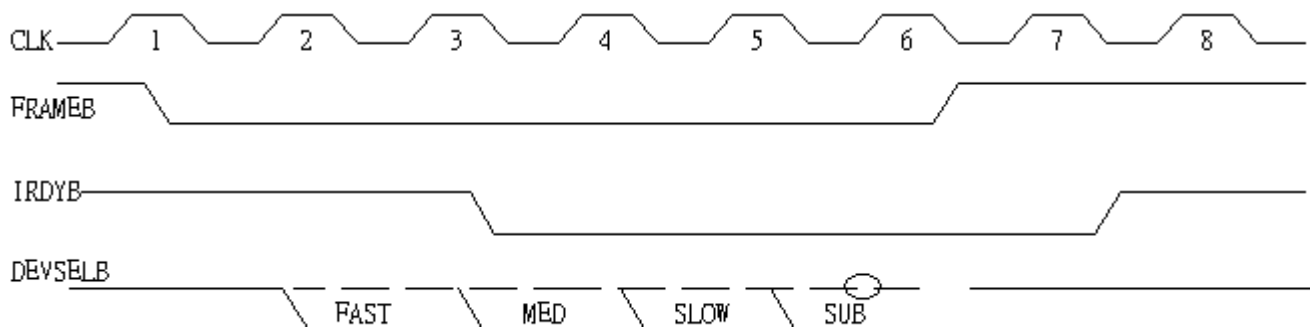
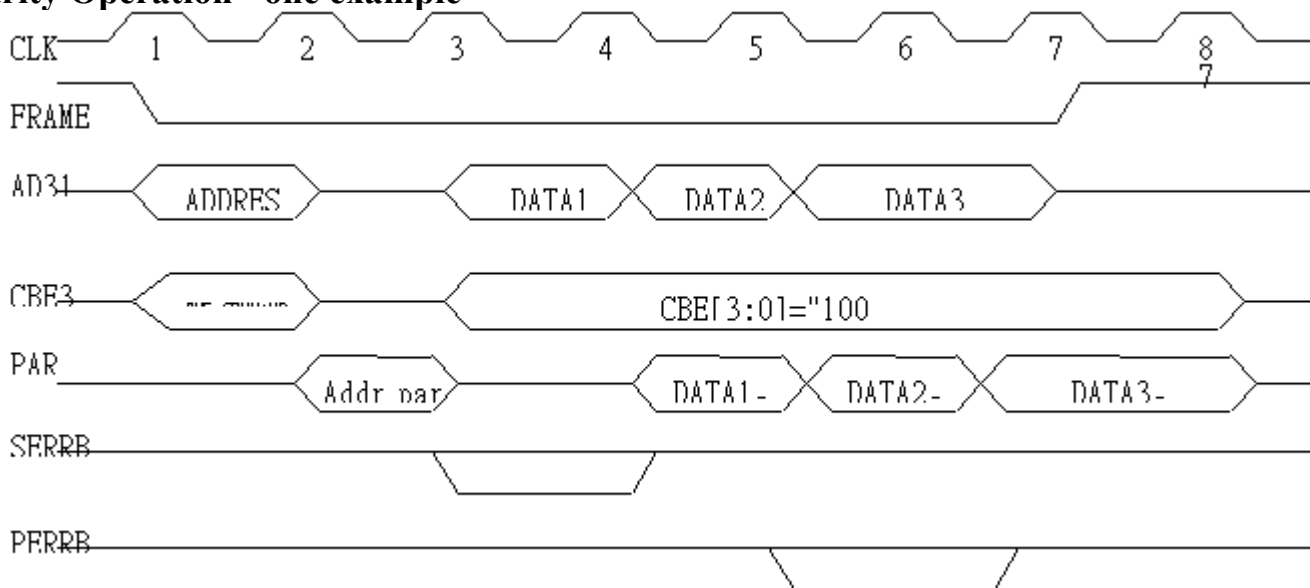
**Memory Write**

**Target Initiated Termination - Retry**

**Target Initiated Termination - Disconnect**

**Target Initiated Termination - Abort**

**Master Initiated Termination – Abort**

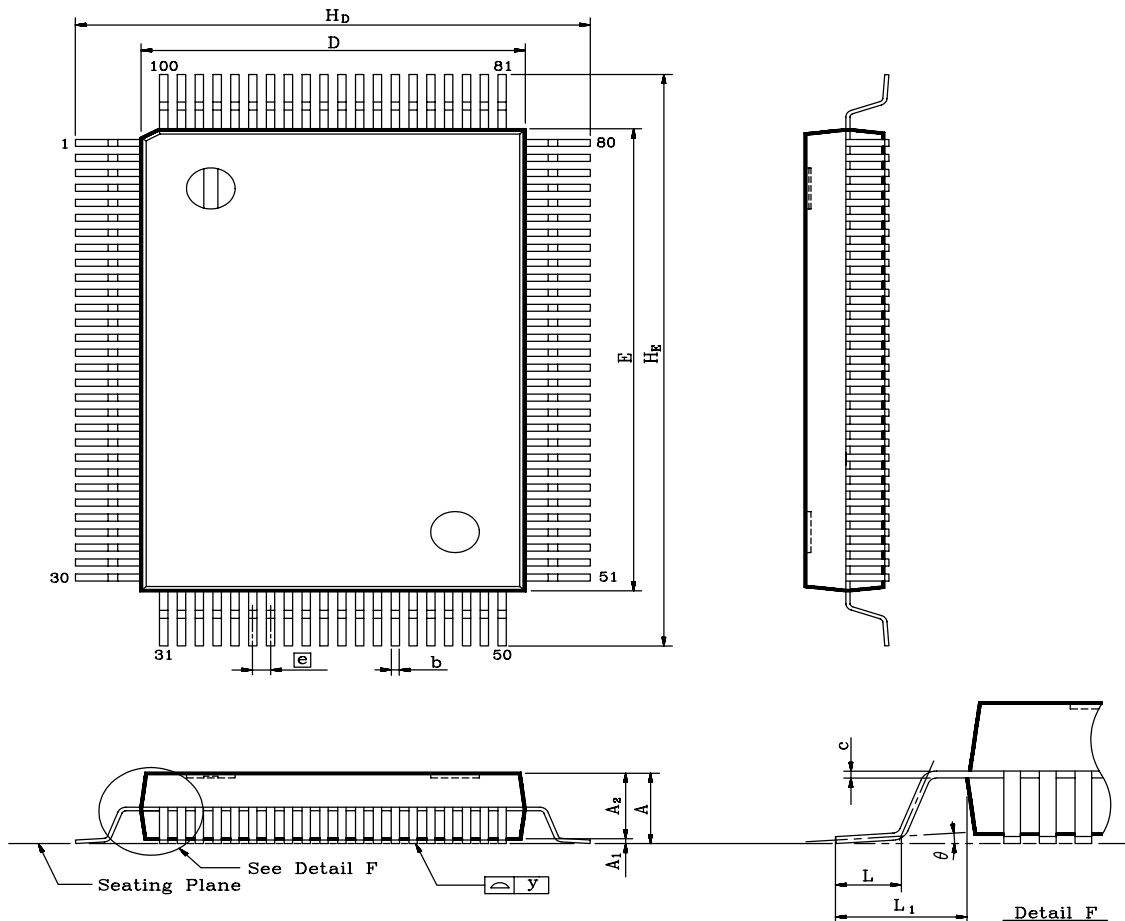
**Parity Operation - one example**

## 12. Mechanical Dimensions

### 12.1 QFP

**Notes:**

- 1.Dimension D & E do not include interlead flash.
- 2.Dimension b does not include dambar protrusion/intrusion.
- 3.Controlling dimension: Millimeter
- 4.General appearance spec. should be based on final visual inspection spec.

Symbol	Dimension in mil			Dimension in mm		
	Min	Typical	Max	Min	Typical	Max
<b>A</b>	106.3	118.1	129.9	2.70	<b>3.00</b>	3.30
<b>A<sub>1</sub></b>	4.3	20.1	35.8	0.11	<b>0.51</b>	0.91
<b>A<sub>2</sub></b>	102.4	112.2	122.0	2.60	<b>2.85</b>	3.10
<b>b</b>	7.1	11.8	16.5	0.18	<b>0.30</b>	0.42
<b>c</b>	1.6	5.9	10.2	0.04	<b>0.15</b>	0.26
<b>D</b>	541.3	551.2	561.0	13.75	<b>14.00</b>	14.25
<b>E</b>	777.6	787.4	797.2	19.75	<b>20.00</b>	20.25
<b>e</b>	19.7	25.6	31.5	0.50	<b>0.65</b>	0.80
<b>H<sub>D</sub></b>	726.4	740.2	753.9	18.45	<b>18.80</b>	19.15
<b>H<sub>E</sub></b>	962.6	976.4	990.2	24.45	<b>24.80</b>	25.15
<b>L</b>	39.4	47.2	55.1	1.00	<b>1.20</b>	1.40
<b>L<sub>1</sub></b>	88.6	94.5	104.3	2.25	<b>2.40</b>	2.65
<b>Y</b>	-	-	3.9	-	-	0.10
<b>θ</b>	0°	-	12°	0°	-	12°

TITLE : 100L QFP ( 14x20 mm**2 ) FOOTPRINT 4.8 mm			
PACKAGE OUTLINE DRAWING			
LEADFRAME MATERIAL:			
APPROVE		DWG NO.	
		REV NO.	
		SCALE	
CHECK	Ricardo Chen	DATE	
		SHT NO.	1 OF
<b>REALTEK SEMICONDUCTOR CORP.</b>			

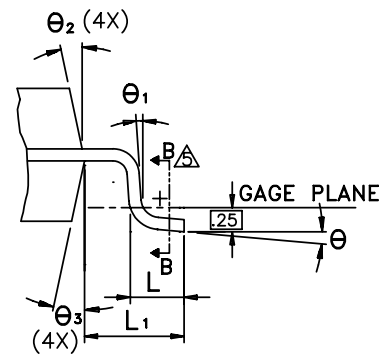
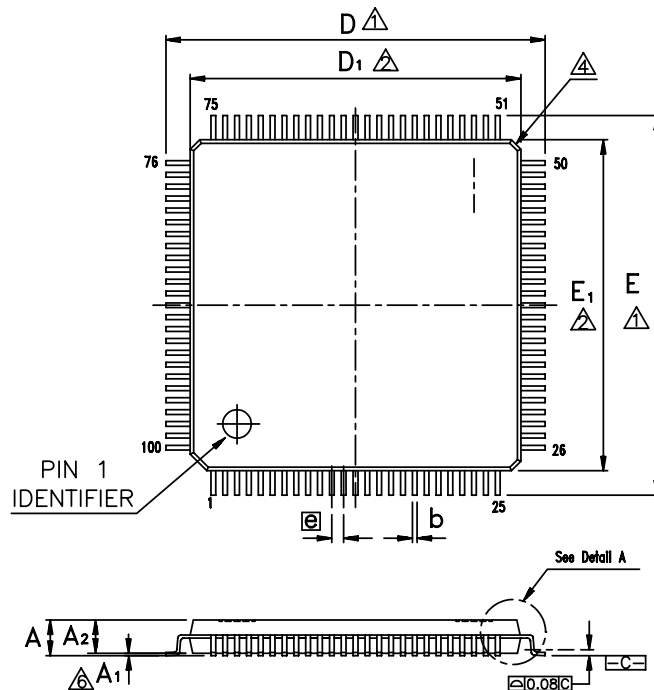
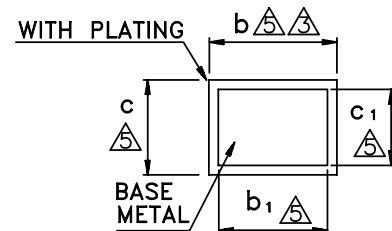

## 12.2 LQFP

**DETAIL A**

**SECTION B-B**
**Notes:**

1. To be determined at seating plane -c-
2. Dimensions D<sub>1</sub> and E<sub>1</sub> do not include mold protrusion.  
D<sub>1</sub> and E<sub>1</sub> are maximum plastic body size dimensions including mold mismatch.
3. Dimension b does not include dambar protrusion.  
Dambar can not be located on the lower radius of the foot.
4. Exact shape of each corner is optional.
5. These dimensions apply to the flat section of the lead between 0.10 mm and 0.25 mm from the lead tip.
6. A<sub>1</sub> is defined as the distance from the seating plane to the lowest point of the package body.
7. Controlling dimension : millimeter.
8. Reference document : JEDEC MS-026 , BED.

Symbol	Dimension in inch			Dimension in mm		
	Min	Nom	Max	Min	Nom	Max
<b>A</b>	-	-	0.067	-	-	1.70
<b>A<sub>1</sub></b>	0.000	0.004	0.008	0.00	<b>0.1</b>	0.20
<b>A<sub>2</sub></b>	0.051	0.055	0.059	1.30	<b>1.40</b>	1.50
<b>b</b>	0.006	0.009	0.011	0.15	<b>0.22</b>	0.29
<b>b<sub>1</sub></b>	0.006	0.008	0.010	0.15	<b>0.20</b>	0.25
<b>c</b>	0.004	-	0.008	0.09	-	0.20
<b>c<sub>1</sub></b>	0.004	-	0.006	0.09	-	0.16
<b>D</b>	0.630 BSC			16.00 BSC		
<b>D<sub>1</sub></b>	0.551 BSC			14.00 BSC		
<b>E</b>	0.630 BSC			16.00 BSC		
<b>E<sub>1</sub></b>	0.551 BSC			14.00 BSC		
<b>e</b>	0.020 BSC			0.50 BSC		
<b>L</b>	0.016	0.024	0.031	0.40	0.60	0.80
<b>L<sub>1</sub></b>	0.039 REF			1.00 REF		
<b>θ</b>	0°	3.5°	9°	0°	3.5°	9°
<b>θ<sub>1</sub></b>	0°	-	-	0°	-	-
<b>θ<sub>2</sub></b>	12°TYP			12°TYP		
<b>θ<sub>3</sub></b>	12°TYP			12°TYP		

TITLE : 100LD LQFP ( 14x14x1.4mm)			
PACKAGE OUTLINE DRAWING , FOOTPRINT 2.0mm			
LEADFRAME MATERIAL:			
APPROVE		DOC. NO.	
		VERSION	1
		PAGE	OF
CHECK		DWG NO.	LQ100 - P1
		DATE	
<b>REALTEK SEMICONDUCTOR CORP.</b>			

---

**Realtek Semiconductor Corp.****Headquarters**

No. 2, Industry East Road IX, Science-based  
Industrial Park, Hsinchu, 300, Taiwan, R.O.C.  
Tel : 886-3-5780211 Fax : 886-3-5776047  
WWW: [www.realtek.com.tw](http://www.realtek.com.tw)

---